



# MEASUREMENT REPORT

## EN 300 328 V1.9.1 WLAN 802.11b/g/n

---

**Applicant:** Compex Systems Pte Ltd  
**Address:** 135 Joo Seng Road, #08-01 PM Industrial Building  
Singapore 368363  
**Product:** 802.11ac Dual Band Module  
**Model No.:** WLE600VX  
**Brand Name:** COMPEX  
**Standards:** ETSI EN 300 328 V1.9.1 (2015-02)  
**Result:** Complies  
**Test Date:** December 28,2016 ~ January 11, 2017

Reviewed By : Robin Wu  
( Robin Wu )

Approved By : Marlinchen  
( Marlin Chen )



The test results relate only to the samples tested.

The test results shown in the test report are traceable to the national/international standards through the calibration of the equipment and evaluated measurement uncertainty herein.

The test report shall not be reproduced except in full without the written approval of MRT Technology (Suzhou) Co., Ltd.

---

### Revision History

Report No.	Version	Description	Issue Date	Note
1612RSU02401	Rev. 01	Initial report	01-14-2017	Valid

---

## CONTENTS

Description	Page
<b>1. General Information.....</b>	<b>5</b>
1.1. Applicant.....	5
1.2. Manufacturer .....	5
1.3. Testing Facility .....	5
1.4. Feature of Equipment under Test.....	6
1.5. Product Specification Subjective to this Report.....	6
1.6. Operation Frequency / Channel List .....	7
1.7. Description of Available Antennas.....	7
1.8. Description of Antenna RF Port .....	8
1.9. Application Form for Testing.....	9
1.10. Standards Applicable for Testing .....	10
<b>2. Test Configuration of Equipment under Test.....</b>	<b>11</b>
2.1. Description of Test Mode .....	11
2.2. Description of Test Data Rate .....	12
2.3. Description of Test Software .....	13
<b>3. Test Summary .....</b>	<b>14</b>
<b>4. RF Output Power .....</b>	<b>15</b>
4.1. Limit.....	15
4.2. Test Setup .....	15
4.3. Test Procedure .....	15
4.4. Test Result.....	16
<b>5. Power Spectral Density .....</b>	<b>19</b>
5.1. Limit.....	19
5.2. Test Setup .....	19
5.3. Test Procedure .....	19
5.4. Test Result.....	20
<b>6. Duty Cycle, Tx-sequence, Tx-gap.....</b>	<b>21</b>
6.1. Limit.....	21
6.2. Test Setup .....	21
6.3. Test Procedure .....	21
6.4. Test Result.....	21
<b>7. Medium Utilisation (MU) Factor .....</b>	<b>22</b>
7.1. Limit.....	22
7.2. Test Setup .....	22
7.3. Test Procedure .....	22

---

7.4. Test Result.....	22
<b>8. Adaptivity and Receiver Blocking .....</b>	<b>23</b>
8.1. Limit.....	23
8.2. Test Setup .....	24
8.3. Test Procedure .....	24
8.4. Test Result.....	25
<b>9. Occupied Channel Bandwidth .....</b>	<b>32</b>
9.1. Limit.....	32
9.2. Test Setup .....	32
9.3. Test Procedure .....	32
9.4. Test Result.....	33
<b>10. Transmitter unwanted emissions in the out-of-band domain.....</b>	<b>38</b>
10.1. Limit.....	38
10.2. Test Setup .....	38
10.3. Test Procedure .....	38
10.4. Test Result.....	39
<b>11. Transmitter Unwanted Emissions in the Spurious Domain .....</b>	<b>42</b>
11.1. Limit.....	42
11.2. Test Setup .....	42
11.3. Test Procedure .....	43
11.4. Test Result.....	44
<b>Test with ANT 4# .....</b>	<b>48</b>
<b>12. Receiver Spurious Emissions.....</b>	<b>52</b>
12.1. Limit.....	52
12.2. Test Setup .....	52
12.3. Test Procedure .....	52
12.4. Test Result.....	53
<b>Test with ANT 4# .....</b>	<b>57</b>
<b>13. Measurement Uncertainty .....</b>	<b>61</b>
<b>14. List of Measuring Instrument.....</b>	<b>62</b>

## 1. General Information

### 1.1. Applicant

Compex Systems Pte Ltd  
135 Joo Seng Road, #08-01 PM Industrial Building Singapore 368363

### 1.2. Manufacturer

Compex Systems Pte Ltd  
135 Joo Seng Road, #08-01 PM Industrial Building Singapore 368363

### 1.3. Testing Facility

#### Test Site

MRT Technology (Suzhou) Co., Ltd

#### Test Site Location

D8 Building, Youxin Industrial Park, No.2 Tian'edang Rd., Wuzhong Economic Development Zone, Suzhou, China

### Test Facility / Accreditations

Measurements were performed at MRT Laboratory located in Tian'edang Rd., Suzhou, China.

- MRT facility is a FCC registered (MRT Reg. No. 809388) test facility with the site description report on file and has met all the requirements specified in Section 2.948 of the FCC Rules.
- MRT facility is an IC registered (MRT Reg. No. 11384A-1) test laboratory with the site description on file at Industry Canada.
- MRT facility is a VCCI registered (R-4179, G-814, C-4664, T-2206) test laboratory with the site description on file at VCCI Council.
- MRT Lab is accredited to ISO 17025 by the American Association for Laboratory Accreditation (A2LA) under the American Association for Laboratory Accreditation Program (A2LA Cert. No. 3628.01) in EMC, Telecommunications and Radio testing for FCC, Industry Canada, EU and TELEC Rules.



#### 1.4. Feature of Equipment under Test

Product Name:	802.11ac Dual Band Module
Model No.:	WLE600VX
Brand Name:	COMPEX
Wi-Fi Specification:	802.11a/b/g/n/ac
Frequency Range:	<p><b>2.4GHz:</b></p> <p>For 802.11b/g/n-HT20: 2412 ~ 2472 MHz</p> <p>For 802.11n-HT40: 2422 ~ 2462 MHz</p> <p><b>5GHz:</b></p> <p>For 802.11a /n-HT20/ac-VHT20: 5180~5240 MHz, 5260~5320 MHz, 5500~5700 MHz, 5745 ~ 5825MHz</p> <p>For 802.11n-HT40/ac-VHT40: 5190~5230 MHz, 5270~5310 MHz, 5510~5670 MHz</p> <p>For 802.11ac-VHT80: 5210 MHz, 5290 MHz, 5530 MHz, 5610 MHz</p>

#### 1.5. Product Specification Subjective to this Report

Frequency Range:	802.11b/g/n-HT20: 2412 ~ 2472MHz 802.11n-HT40: 2422 ~ 2462MHz
Channel Number:	802.11b/g/n-HT20: 13 802.11n-HT40: 9
Type of Modulation:	802.11b: DSSS 802.11g/n: OFDM
Data Rate:	802.11b: 1/2/5.5/11Mbps 802.11g: 6/9/12/18/24/36/48/54Mbps 802.11n: up to 300Mbps

Note: For other features of this EUT, test report will be issued separately.

## 1.6. Operation Frequency / Channel List

802.11b/g/n-HT20

Channel	Frequency	Channel	Frequency	Channel	Frequency
01	2412 MHz	02	2417 MHz	03	2422 MHz
04	2427 MHz	05	2432 MHz	06	2437 MHz
07	2442 MHz	08	2447 MHz	09	2452 MHz
10	2457 MHz	11	2462 MHz	12	2467 MHz
13	2472 MHz	N/A	N/A	N/A	N/A

802.11n-HT40

Channel	Frequency	Channel	Frequency	Channel	Frequency
03	2422 MHz	04	2427 MHz	05	2432 MHz
06	2437 MHz	07	2442 MHz	08	2447 MHz
09	2452 MHz	10	2457 MHz	11	2462 MHz

## 1.7. Description of Available Antennas

Antenna Type	Manufacturer	Tx Paths	Max Directional Gain (dBi)
Dipole Antenna 1#	Kunshan Wavelink Electronic Co., Ltd.	3	2.4GHz: 2.0, 5GHz: 2.0
Dipole Antenna 2#	Smart Ant Inc	3	2.4GHz: 4.5, 5GHz: 7.0
PCB Antenna 3#	TAOGLAS Inc	3	2.4GHz: 4.5, 5GHz: 6.7
PCB Antenna 4#	Compex Systems Pte Ltd	3	2.4GHz: 5.0, 5GHz: 5.0
PCB Antenna 5#	Compex Systems Pte Ltd	3	2.4GHz: 5.0, 5GHz: 5.0

Note: We selected the dipole antenna 2# and PCB antenna 4# for all radiated emission testing.

### 1.8. Description of Antenna RF Port

--	2.4/5GHz Antenna RF Port	
	2.4/5GHz	2.4/5GHz
Software Control Port	Ant 0	Ant 1

**Antenna RF Port Plot**

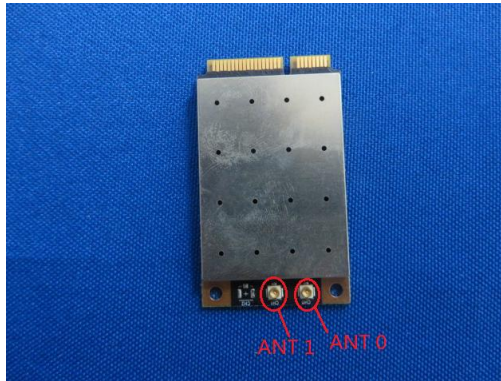



### 1.9. Application Form for Testing

Modulation Type	
<input type="checkbox"/>	FHSS
<input checked="" type="checkbox"/>	other forms of modulation
Adaptivity Equipment	
<input type="checkbox"/>	Non-Adaptive Equipment:
	The maximum RF Output Power (e.i.r.p.): ... dBm
	The maximum (corresponding) Duty Cycle: ... %
<input checked="" type="checkbox"/>	Adaptive Equipment without the possibility to switch to a non-adaptive mode:
<input checked="" type="checkbox"/>	The equipment has implemented an LBT based DAA mechanism:
<input type="checkbox"/>	The equipment is Frame Based equipment
<input checked="" type="checkbox"/>	The equipment is Load Based equipment
<input type="checkbox"/>	The equipment can switch dynamically between Frame Based and Load Based equipment
<input type="checkbox"/>	The equipment has implemented an non-LBT based DAA mechanism
<input type="checkbox"/>	The equipment can operate in more than one adaptive mode
<input type="checkbox"/>	Adaptive Equipment which can also operate in a non-adaptive mode
The Worst Case Operational Mode for Each of The Following Tests	
<input checked="" type="checkbox"/>	RF Output Power: 19.94dBm
<input checked="" type="checkbox"/>	Power Spectral Density: 9.81dBm/MHz
<input type="checkbox"/>	Duty cycle, Tx-Sequence, Tx-gap
<input type="checkbox"/>	Accumulated Transmit time, Frequency Occupation & Hopping Sequence
<input type="checkbox"/>	Medium Utilisation:
<input type="checkbox"/>	Hopping Frequency Separation:
<input checked="" type="checkbox"/>	Adaptivity & Receiver Blocking: 2.071ms, 134.3us
<input checked="" type="checkbox"/>	Occupied Nominal Channel Bandwidth: 36.33MHz
<input checked="" type="checkbox"/>	Transmitter unwanted emissions in the OOB domain: -11.42dBm/MHz
<input checked="" type="checkbox"/>	Transmitter unwanted emissions in the spurious domain: -43.4dBm
<input checked="" type="checkbox"/>	Receiver spurious emissions: -53.2dBm
Antenna Category	
<input checked="" type="checkbox"/>	Integral antenna (antenna permanently attached)
<input checked="" type="checkbox"/>	Temporary RF connector provided
<input type="checkbox"/>	No temporary RF connector provided

Device Type	
<input checked="" type="checkbox"/>	Stand-alone equipment
<input type="checkbox"/>	Combined (or host) equipment
<input type="checkbox"/>	Test Jig
Operating Conditions	
<input type="checkbox"/>	AC Mains State AC Voltage:
<input checked="" type="checkbox"/>	DC State DC Voltage: 3.0 ~ 3.6 V
Type of DC Source <input type="checkbox"/> Internal power supply	
<input type="checkbox"/> External power supply or AC/DC adapter	
<input type="checkbox"/> Battery	
<input checked="" type="checkbox"/>	Temperature Range: -20 ~ 70°C
Geo-location capability supported by the equipment	
<input type="checkbox"/>	Yes <input type="checkbox"/> The geographical location determined by the equipment is not accessible to the user.
<input checked="" type="checkbox"/>	No

### 1.10. Standards Applicable for Testing

The EUT complies with the requirements of ETSI EN 300 328 V1.9.1.

## 2. Test Configuration of Equipment under Test

### 2.1. Description of Test Mode

Test Mode
Mode 1: Transmit by 802.11b
Mode 2: Transmit by 802.11g
Mode 3: Transmit by 802.11n-HT20
Mode 4: Transmit by 802.11n-HT40
Mode 5: Receive by 802.11b
Mode 6: Receive by 802.11g
Mode 7: Receive by 802.11n-HT20
Mode 8: Receive by 802.11n-HT40

## 2.2. Description of Test Data Rate

Pre-Test RF Output Power at various data rates for Ant 1

Test Mode	Bandwidth (MHz)	Channel No.	Frequency (MHz)	Data Rate (Mbps)	RF Output Power (dBm)
11b	20	7	2442	1	12.62
				5.5	12.34
				11	12.02
11g	20	7	2442	6	14.03
				24	13.84
				54	13.65
11n	20	7	2442	19.5	13.94
				21.7	13.89
				78.0	13.54
				86.7	13.47
				195.0	12.96
				216.7	12.89
11n	40	7	2442	40.5	14.19
				45.0	14.02
				162.0	13.62
				180.0	13.51
				405.0	12.98
				450.0	12.91

Note: All modes of operation and data rates were investigated, so all RF test requirements shall be executed at low data rates.

### 2.3. Description of Test Software

The test utility software used during testing was “ART”.

Final Power Parameter Value of the test software as below.

Test Mode	Test Frequency	Power Parameter Value		
		Ant 0	Ant 1	Ant 0 + 1
802.11b	2412	10.0	10.0	Not Support
	2442	10.5	10.5	
	2472	11.0	10.5	
802.11g	2412	12.0	12.0	Not Support
	2442	12.5	12.5	
	2472	13.0	12.0	
802.11n-HT20	2412	12.0	12.5	9.0
	2442	12.5	12.5	9.5
	2472	13.0	12.5	9.5
802.11n-HT40	2422	12.0	12.5	9.5
	2442	12.5	12.5	10.0
	2462	13.0	12.5	10.5

### 3. Test Summary

Clause (EN 300328)	Test Parameter	Result (Pass/Fail)	Remark
<b>Transmitter Parameter</b>			
4.3.2.2	RF Output Power	Pass	---
4.3.2.3	Power Spectral Density	Pass	---
4.3.2.7	Occupied Channel Bandwidth	Pass	---
4.3.2.8	Transmitter Unwanted Emissions in the out-of-band Domain	Pass	---
4.3.2.9	Transmitter Spurious Emissions	Pass	---
<b>Receiver Parameters</b>			
4.3.2.10	Receiver Spurious Emissions	Pass	---
<b>Adaptive Test Item</b>			
4.3.2.6	Adaptivity	Pass	---
4.3.2.11	Receiver Blocking	Pass	
<b>Non-Adaptive Test Item</b>			
4.3.2.4	Duty cycle, Tx-Sequence, Tx-gap	N/A	Only applicable for non-adaptive equipment with output power >10dBm
4.3.2.5	Medium Utilisation (MU) factor	N/A	
<b>Geo-location Mechanism</b>			
4.3.2.12	Geo-location Capability	N/A	---
<p>Note 1: The EUT can operate in a adaptive mode with EIRP greater than 10dBm, and can't operate in a non-adaptive mode which was declared by the supplier.</p> <p>Note 2: For radiated spurious emission test, every axis (X, Y, Z) was also verified. The test results shown in the following sections represent the worst case emissions (Y axis), and the test setup showed in test setup photo.</p>			

## 4. RF Output Power

### 4.1. Limit

The maximum RF output power for adaptive equipment using wide band modulations other than FHSS shall be equal to or less than 20dBm.

Test Conditions	Limit
Normal and Extreme Temperature Conditions	20dBm (E.I.R.P)

### 4.2. Test Setup

For Conducted Measurement

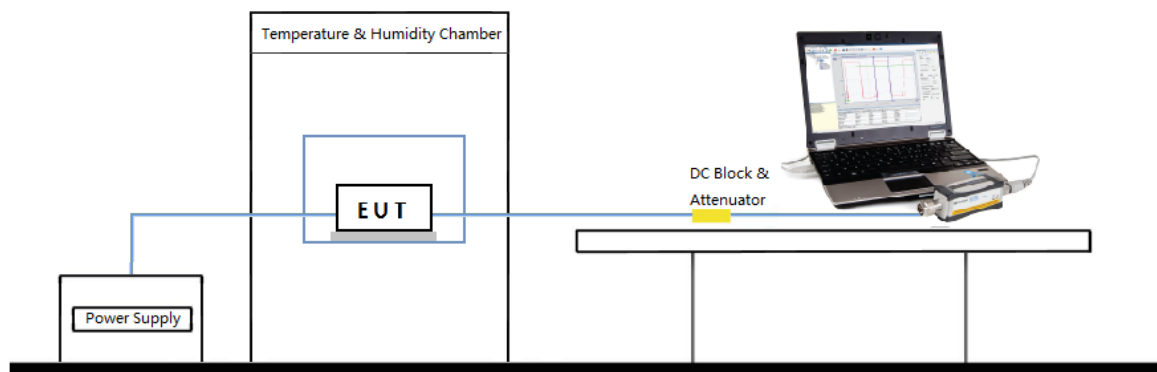

### 4.3. Test Procedure

Refer to ETSI EN 300 328 V1.9.1 (2015-02) Clause 5.3.2.2.1.

#### 4.4. Test Result

Product	802.11ac Dual Band Module	Temperature	-20 ~ 70°C
Test Engineer	Roy Cheng	Relative Humidity	50 ~ 58%
Test Site	TR3	Test Date	2016/12/29

#### Normal Conditions (Temperature 25°C)

##### 1T<sub>x</sub>

Mode	Ch. No.	Freq. (MHz)	RF Output Power (dBm)		Max EIRP Power (dBm)	Limit (dBm)	Result
			Ant 0	Ant 1			
11b	1	2412	12.25	12.48	17.48	20	Pass
11b	7	2442	12.42	12.62	17.62	20	Pass
11b	13	2472	12.33	12.51	17.51	20	Pass
11g	1	2412	13.54	13.74	18.74	20	Pass
11g	7	2442	13.89	14.03	19.03	20	Pass
11g	13	2472	14.03	14.11	19.11	20	Pass
11n-HT20	1	2412	13.84	14.21	19.21	20	Pass
11n-HT20	7	2442	13.79	13.94	18.94	20	Pass
11n-HT20	13	2472	13.82	14.22	19.22	20	Pass
11n-HT40	3	2422	13.83	14.11	19.11	20	Pass
11n-HT40	7	2442	14.03	14.19	19.19	20	Pass
11n-HT40	11	2462	13.79	14.26	19.26	20	Pass

Note: EIRP Power (dBm) = RF Output Power (dBm) + Antenna Gain (dBi).

##### 2T<sub>x</sub>

Mode	Ch. No.	Freq. (MHz)	RF Output Power (dBm)		Total EIRP Power (dBm)	Limit (dBm)	Result
			Ant 0	Ant 1			
11n-HT20	1	2412	11.26	11.28	19.28	20	Pass
11n-HT20	7	2442	11.24	11.28	19.27	20	Pass
11n-HT20	13	2472	11.01	11.32	19.18	20	Pass
11n-HT40	3	2422	10.74	10.68	18.72	20	Pass
11n-HT40	7	2442	10.85	10.91	18.89	20	Pass
11n-HT40	11	2462	11.22	11.24	19.24	20	Pass

Note: Total EIRP Power (dBm) =  $10 \cdot \log\{10^{(\text{Ant 0 RF Output Power}/10)} + 10^{(\text{Ant 1 RF Output Power}/10)}\}$  (dBm) + Antenna Gain (dBi).



**Extreme Conditions (Temperature -20°C)**
**1T<sub>x</sub>**

Mode	Ch. No.	Freq. (MHz)	RF Output Power (dBm)		Max EIRP Power (dBm)	Limit (dBm)	Result
			Ant 0	Ant 1			
11b	1	2412	12.05	12.42	17.42	20	Pass
11b	7	2442	12.26	12.52	17.52	20	Pass
11b	13	2472	12.52	12.81	17.81	20	Pass
11g	1	2412	13.77	13.84	18.84	20	Pass
11g	7	2442	14.21	14.31	19.31	20	Pass
11g	13	2472	14.06	14.15	19.15	20	Pass
11n-HT20	1	2412	13.84	14.16	19.16	20	Pass
11n-HT20	7	2442	14.03	14.11	19.11	20	Pass
11n-HT20	13	2472	13.91	14.32	19.32	20	Pass
11n-HT40	3	2422	13.95	14.26	19.26	20	Pass
11n-HT40	7	2442	13.96	14.28	19.28	20	Pass
11n-HT40	11	2462	13.77	14.23	19.23	20	Pass

Note: EIRP Power (dBm) = RF Output Power (dBm) + Antenna Gain (dBi).

**2T<sub>x</sub>**

Mode	Ch. No.	Freq. (MHz)	RF Output Power (dBm)		Total EIRP Power (dBm)	Limit (dBm)	Result
			Ant 0	Ant 1			
11n-HT20	1	2412	11.14	11.03	19.10	20	Pass
11n-HT20	7	2442	11.19	11.25	19.23	20	Pass
11n-HT20	13	2472	11.31	11.25	19.29	20	Pass
11n-HT40	3	2422	10.58	10.68	18.64	20	Pass
11n-HT40	7	2442	10.69	10.91	18.81	20	Pass
11n-HT40	11	2462	11.34	11.26	19.31	20	Pass

Note: Total EIRP Power (dBm) =  $10 \cdot \log\{10^{(\text{Ant 0 RF Output Power}/10)} + 10^{(\text{Ant 1 RF Output Power}/10)}\}$  (dBm) + Antenna Gain (dBi).

**Extreme Conditions (Temperature 70°C)**
**1T<sub>x</sub>**

Mode	Ch. No.	Freq. (MHz)	RF Output Power (dBm)		Max EIRP Power (dBm)	Limit (dBm)	Result
			Ant 0	Ant 1			
11b	1	2412	13.22	13.58	18.58	20	Pass
11b	7	2442	13.52	13.62	18.62	20	Pass
11b	13	2472	13.42	13.69	18.69	20	Pass
11g	1	2412	14.81	14.82	19.82	20	Pass
11g	7	2442	14.89	14.88	19.89	20	Pass
11g	13	2472	14.92	14.76	19.92	20	Pass
11n-HT20	1	2412	14.71	14.93	19.93	20	Pass
11n-HT20	7	2442	14.86	14.77	19.86	20	Pass
11n-HT20	13	2472	14.82	14.83	19.83	20	Pass
11n-HT40	3	2422	14.71	14.86	19.86	20	Pass
11n-HT40	7	2442	14.86	14.81	19.86	20	Pass
11n-HT40	11	2462	14.77	14.76	19.77	20	Pass

Note: EIRP Power (dBm) = RF Output Power (dBm) + Antenna Gain (dBi).

**2T<sub>x</sub>**

Mode	Ch. No.	Freq. (MHz)	RF Output Power (dBm)		Total EIRP Power (dBm)	Limit (dBm)	Result
			Ant 0	Ant 1			
11n-HT20	1	2412	11.92	11.84	19.89	20	Pass
11n-HT20	7	2442	11.86	11.92	19.90	20	Pass
11n-HT20	13	2472	11.82	11.92	19.88	20	Pass
11n-HT40	3	2422	11.76	11.91	19.85	20	Pass
11n-HT40	7	2442	11.68	11.88	19.79	20	Pass
11n-HT40	11	2462	11.69	11.86	19.79	20	Pass

Note: Total EIRP Power (dBm) =  $10 \cdot \log\{10^{(\text{Ant 0 RF Output Power}/10)} + 10^{(\text{Ant 1 RF Output Power}/10)}\}$  (dBm) + Antenna Gain (dBi).

## 5. Power Spectral Density

### 5.1. Limit

The maximum Power Spectral Density is limited to 10dBm per MHz for equipment using wide band modulations other than FHSS.

### 5.2. Test Setup

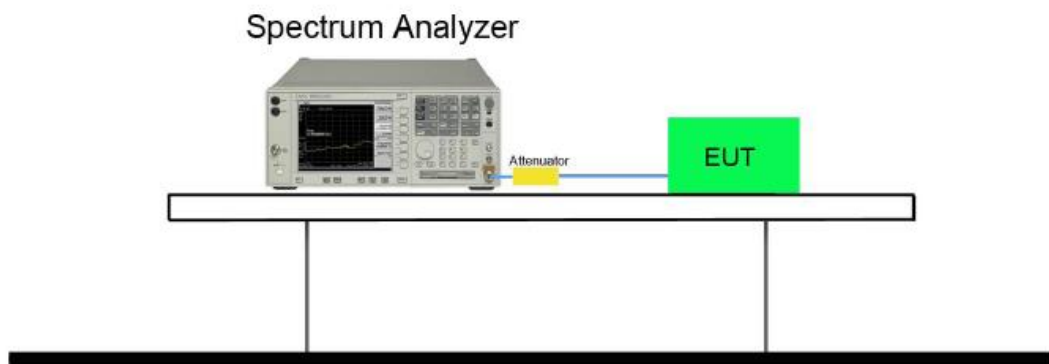

### 5.3. Test Procedure

Refer to ETSI EN 300 328 V1.9.1 (2015-02) Clause 5.3.3.2.1.

#### 5.4. Test Result

Product	802.11ac Dual Band Module	Temperature	25°C
Test Engineer	Roy Cheng	Relative Humidity	54%
Test Site	TR3	Test Date	2017/01/06

#### 1Tx

Mode	Channel	Freq. (MHz)	EIRP Power Density (dBm/MHz) Ant 0	EIRP Power Density (dBm/MHz) Ant 1	Limit (dBm/MHz)	Result
11b	01	2412	9.77	9.89	10	Pass
11b	07	2442	9.67	9.82	10	Pass
11b	13	2472	9.72	9.79	10	Pass
11g	01	2412	8.21	8.46	10	Pass
11g	07	2442	8.18	8.34	10	Pass
11g	13	2472	7.68	7.91	10	Pass
11n-HT20	01	2412	7.81	8.24	10	Pass
11n-HT20	07	2442	7.84	7.96	10	Pass
11n-HT20	13	2472	7.49	7.82	10	Pass
11n-HT40	03	2422	7.92	4.64	10	Pass
11n-HT40	07	2442	7.91	4.42	10	Pass
11n-HT40	11	2462	7.46	4.73	10	Pass

#### 2Tx

Mode	Channel	Frequency (MHz)	Total PSD (dBm/MHz)	Limit (dBm/MHz)	Result
11n-HT20	1	2412	7.27	10	Pass
11n-HT20	7	2442	6.86	10	Pass
11n-HT20	13	2472	7.52	10	Pass
11n-HT40	3	2422	4.76	10	Pass
11n-HT40	7	2442	4.49	10	Pass
11n-HT40	11	2462	4.83	10	Pass

## 6. Duty Cycle, Tx-sequence, Tx-gap

### 6.1. Limit

The Duty Cycle shall be equal to or less than the maximum value declared by the supplier.

The Tx-sequence time shall be equal to or less than 10 ms. The minimum Tx-gap time following a Tx-sequence shall be equal to the duration of that proceeding Tx-sequence with a minimum of 3.5 ms.

### 6.2. Test Setup

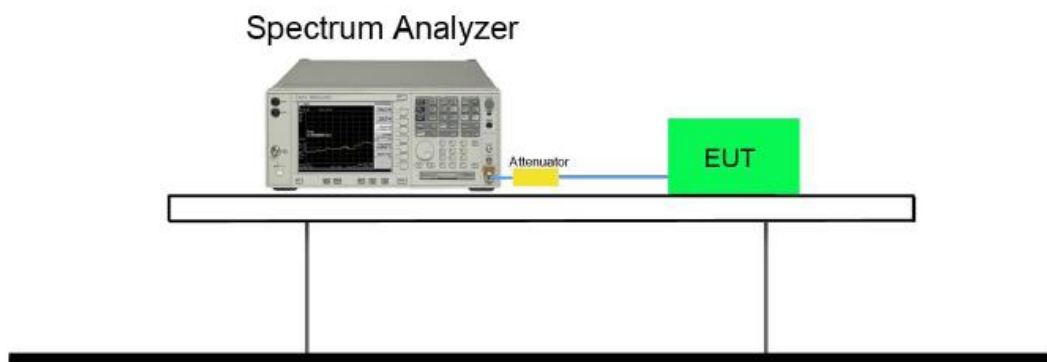

### 6.3. Test Procedure

Refer to ETSI EN 300 328 V1.9.1 (2015-02) Clause 5.3.2.2.1.3.

### 6.4. Test Result

These requirements apply to non-adaptive equipment or to adaptive equipment when operating in a non-adaptive mode. So the item is not applicable.

## 7. Medium Utilisation (MU) Factor

### 7.1. Limit

The maximum Medium Utilisation factor shall be 10 % for non-adaptive equipment using wide band modulations other than FHSS.

### 7.2. Test Setup

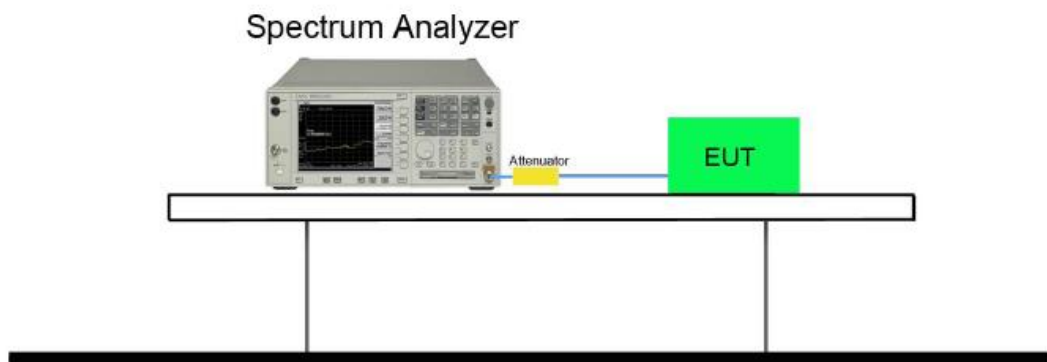

### 7.3. Test Procedure

Refer to ETSI EN 300 328 V1.9.1 (2015-02) Clause 5.3.2.2.1.4.

### 7.4. Test Result

This requirement does not apply to adaptive equipment unless operating in a non-adaptive mode.  
So the item is not applicable.

## 8. Adaptivity and Receiver Blocking

### 8.1. Limit

LBT based Detect and Avoid (Load Based Equipment may implement an LBT based spectrum sharing mechanism as described in IEEE 802.11-2012 clauses 9, 10, 16, 17, 19 and 20 or in IEEE 802.15.4-2011, clauses 4, 5 and 8.)

#### Adaptivity Limit

The CCA observation time shall be not less than 18 us.

The Channel Occupancy Time shall be less than 13 ms.

The minimum idle period shall be not less than 18 us.

When adding the interference signal, the EUT shall stop transmissions on the current operating channel.

#### Short Control Signalling Transmissions Limit

Short Control Signalling Transmissions shall have a maximum ratio of 10% within an observation period of 50ms.

#### Receiver Blocking Limit

Adaptive equipment shall comply with the requirements in the presence of a blocking signal with characteristics as below.

Receiver Blocking parameters				
Equipment Type (LBT / non-LBT)	Wanted signal mean power from companion device	Blocking signal frequency [MHz]	Blocking signal power [dBm]	Type of interfering signal
LBT	Sufficient to maintain the link (see note 2)	2395 or 2488.5 (see note 1)	-35	CW
Non-LBT	-30dBm			

NOTE 1: The highest blocking frequency shall be used for testing operating channels within the range 2 400 MHz to 2 442 MHz, while the lowest blocking frequency shall be used for testing operating channels within the range 2 442 MHz to 2 483,5 MHz.

NOTE 2: A typical value which can be used in most cases is -50 dBm/MHz.

With the interfering signal present, adding the blocking signal, the EUT didn't resume any normal transmissions. When removal the interference and blocking signal, the EUT was allowed to start transmissions again on this channel.

## 8.2. Test Setup

### For conducted measurements

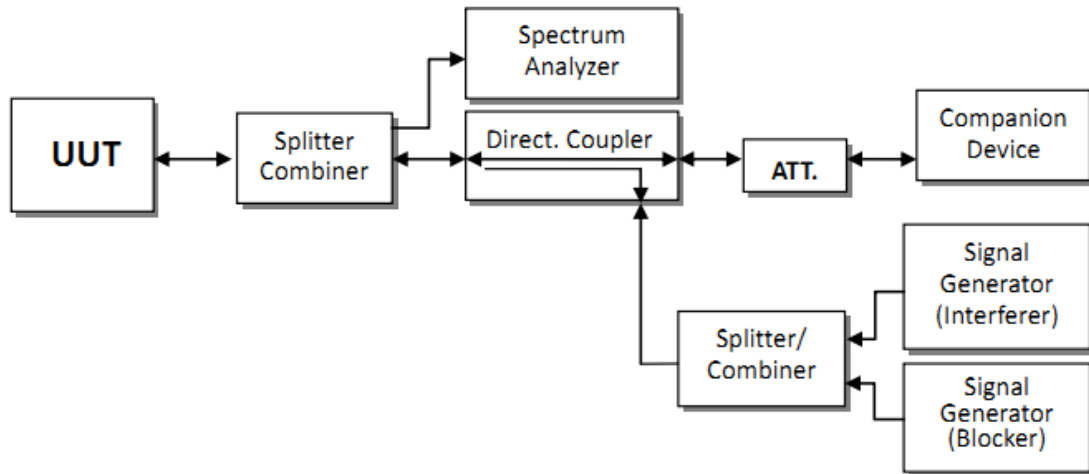

## 8.3. Test Procedure

Refer to ETSI EN 300 328 V1.9.1 (2015-02) Clause 5.3.7.2.1.



### 8.4. Test Result

Product	802.11ac Dual Band Module	Temperature	24°C
Test Engineer	Andy Zhu	Relative Humidity	54%
Test Time	2017/01/11	Test Site	TR3

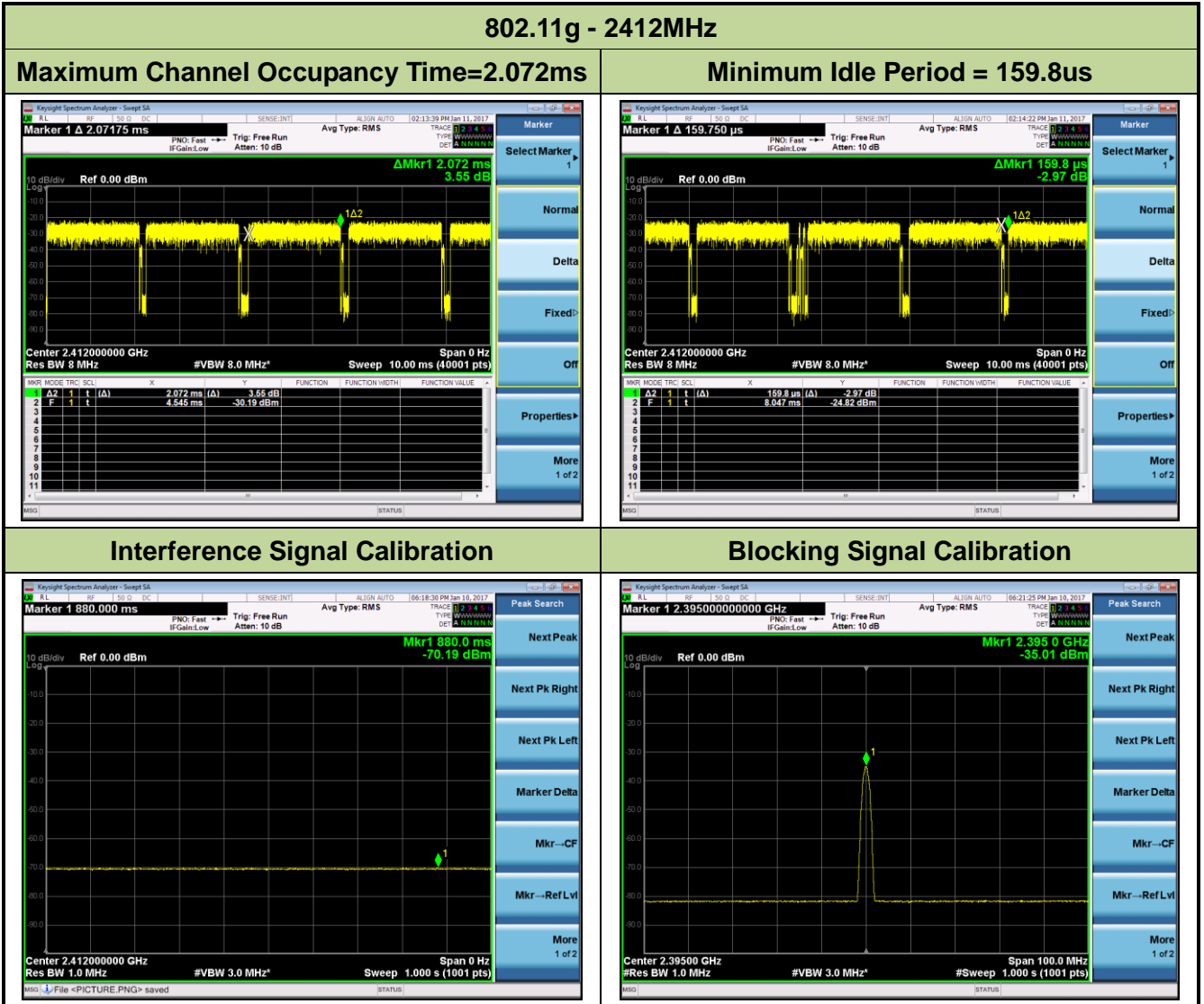

**Transmission stopped after interference added and the short control signaling less than 5ms.  
The UUT did not resume any normal transmissions when adding the blocking signal.**

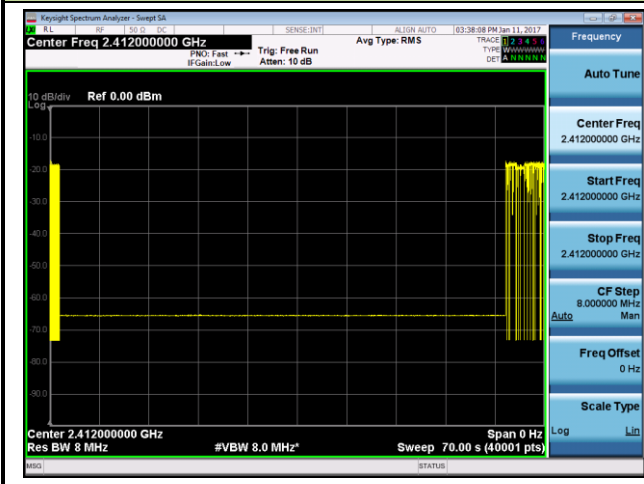

Note: Detection Level =  $-70 \text{ dBm/MHz} + (20 \text{ dBm} - \text{the max conducted power (dBm)})/\text{MHz} \geq -70 \text{ dBm/MHz}$  We used the worst-case detection level (-70dBm/MHz) to perform adaptivity testing.

Test Result:	Pass
--------------	------

### 802.11g - 2472MHz

Maximum Channel Occupancy Time=2.069ms

Minimum Idle Period =156.8us

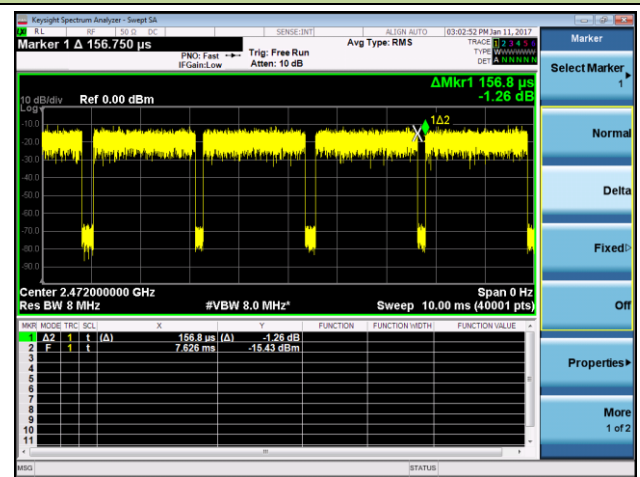
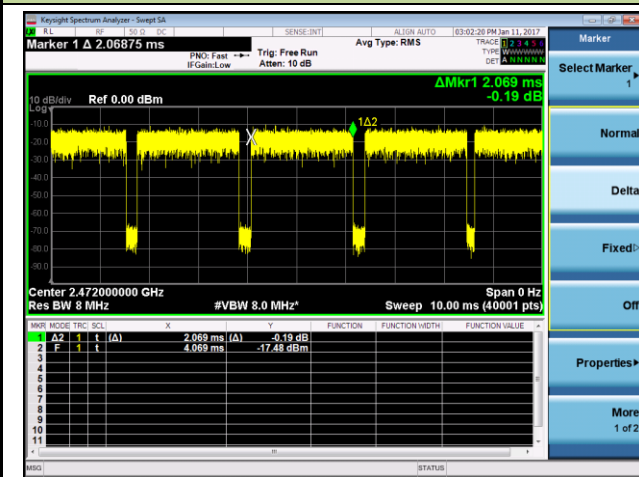

### Interference Signal Calibration

### Blocking Signal Calibration

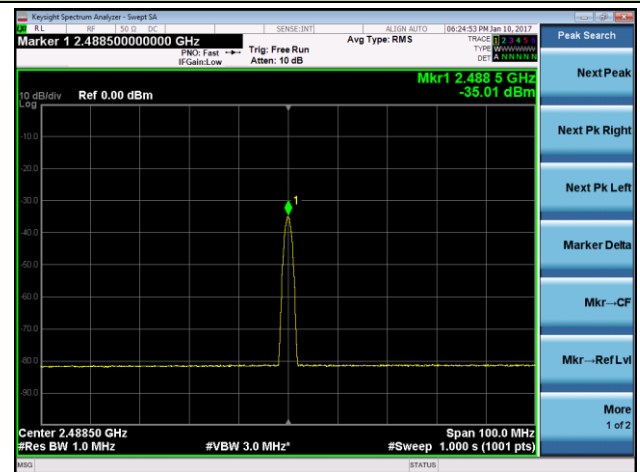

Transmission stopped after interference added and the short control signaling less than 5ms. The UUT did not resume any normal transmissions when adding the blocking signal

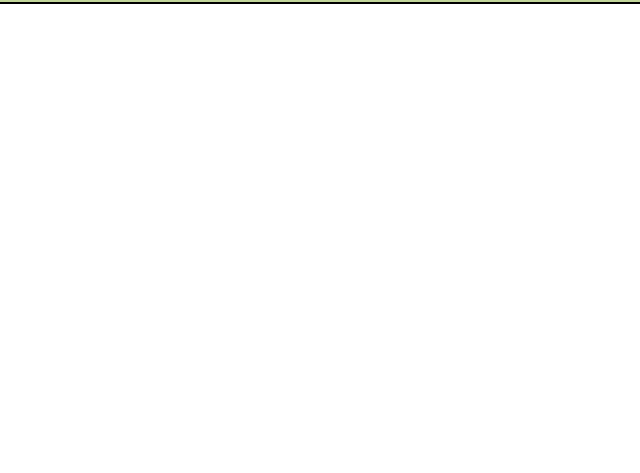
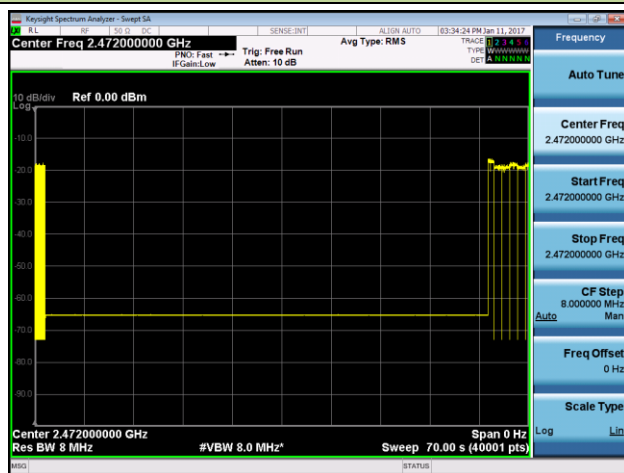

Note: Detection Level =  $-70 \text{ dBm/MHz} + (20 \text{ dBm} - \text{the max conducted power (dBm)})/\text{MHz} \geq -70 \text{ dBm/MHz}$  We used the worst-case detection level (-70dBm/MHz) to perform adaptivity testing.

Test Result: Pass

802.11n-HT20 - 2412MHz

Maximum Channel Occupancy Time=616.3us

Minimum Idle Period = 158.6us

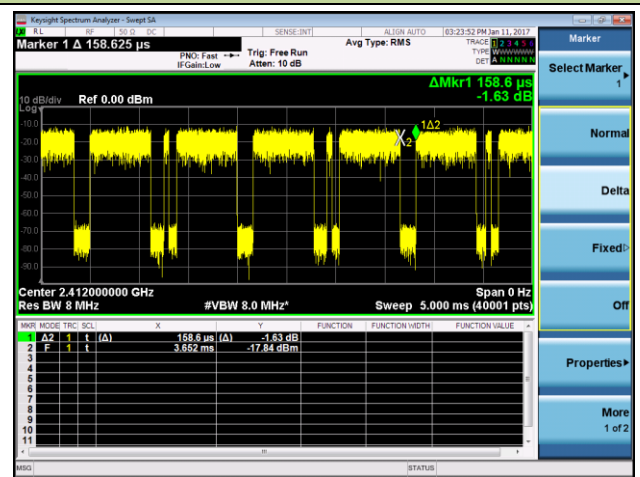
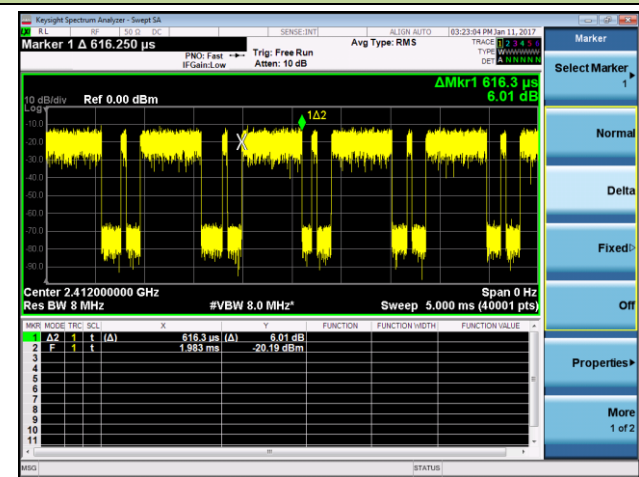

Interference Signal Calibration

Blocking Signal Calibration

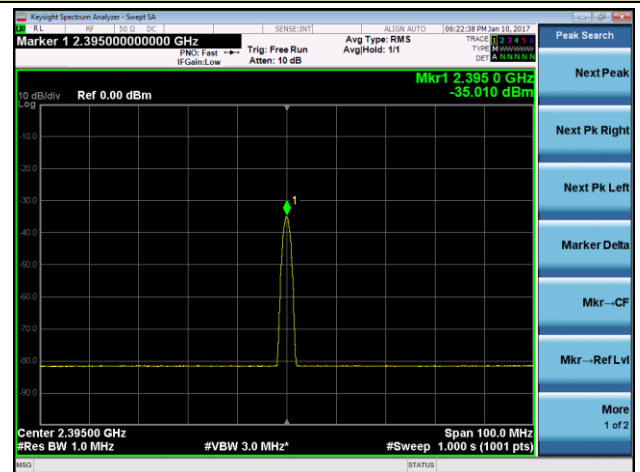
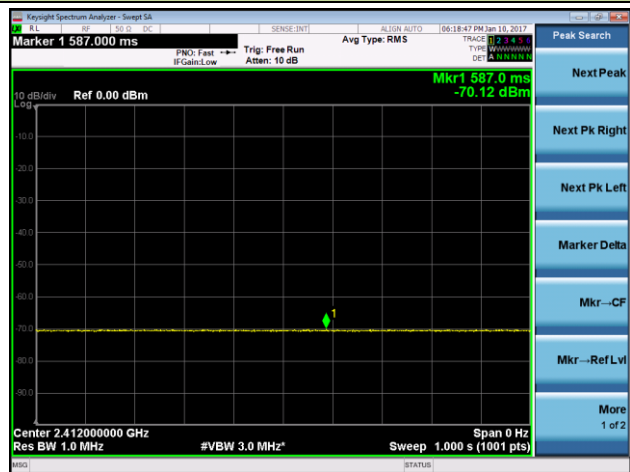

Transmission stopped after interference added and the short control signaling less than 5ms. The UUT did not resume any normal transmissions when adding the blocking signal

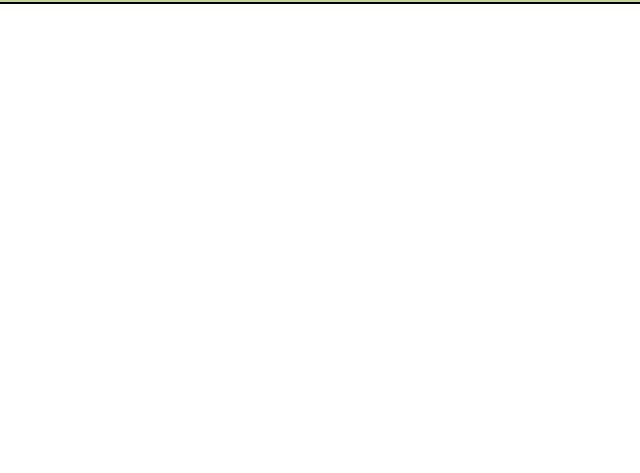
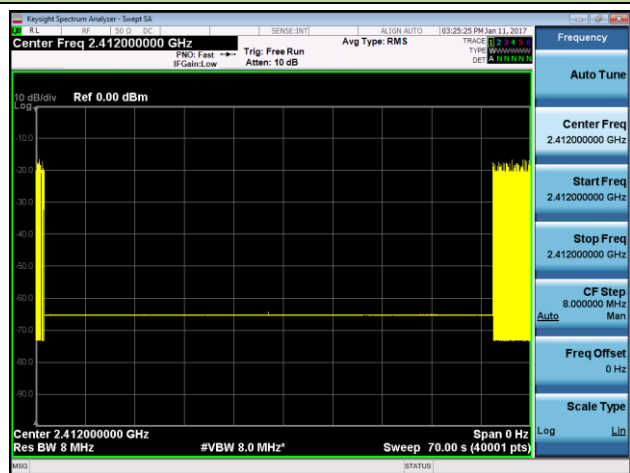

Note: Detection Level =  $-70 \text{ dBm/MHz} + (20 \text{ dBm} - \text{the max conducted power (dBm)})/\text{MHz} \geq -70 \text{ dBm/MHz}$  We used the worst-case detection level (-70dBm/MHz) to perform adaptivity testing.

Test Result: Pass

802.11n-HT20 - 2472MHz

Maximum Channel Occupancy Time=1.181ms

Minimum Idle Period = 82.50us

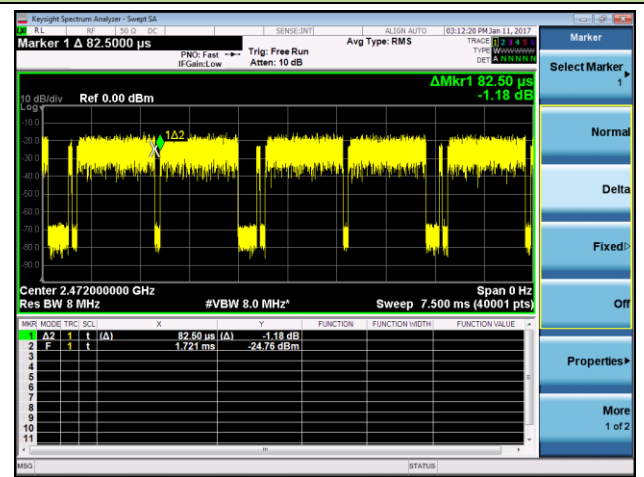
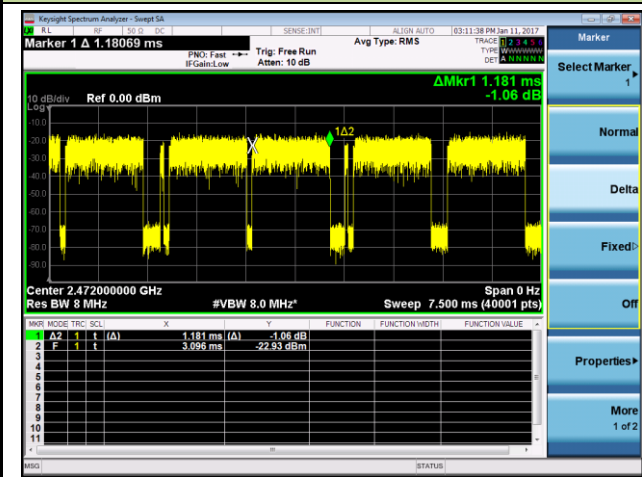

Interference Signal Calibration

Blocking Signal Calibration

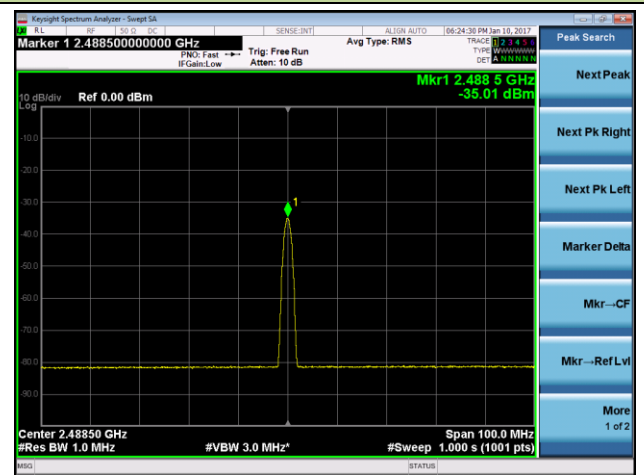
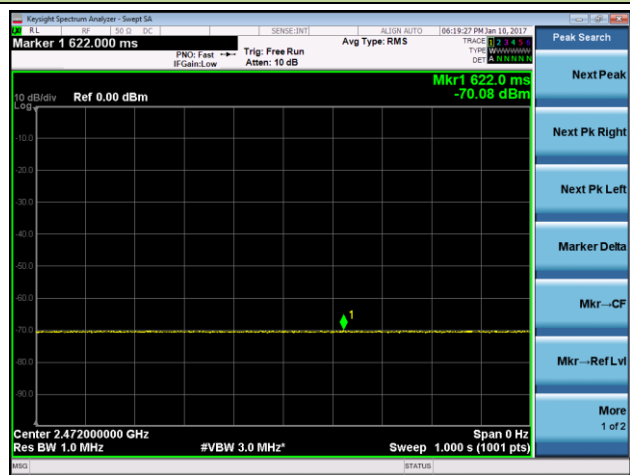

Transmission stopped after interference added and the short control signaling less than 5ms. The UUT did not resume any normal transmissions when adding the blocking signal

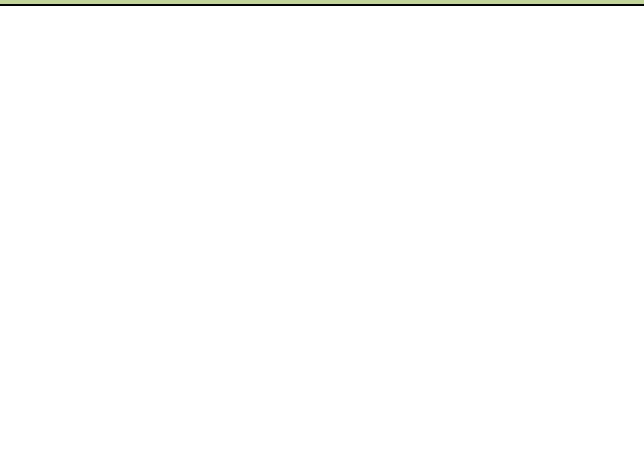
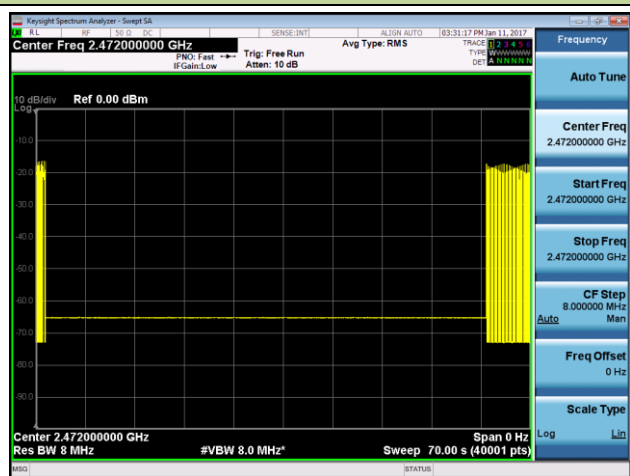

Note: Detection Level =  $-70 \text{ dBm/MHz} + (20 \text{ dBm} - \text{the max conducted power (dBm)})/\text{MHz} \geq -70 \text{ dBm/MHz}$  We used the worst-case detection level (-70dBm/MHz) to perform adaptivity testing.

Test Result: Pass

802.11n-HT40 - 2422MHz

Maximum Channel Occupancy Time=1.185ms

Minimum Idle Period = 161.4us

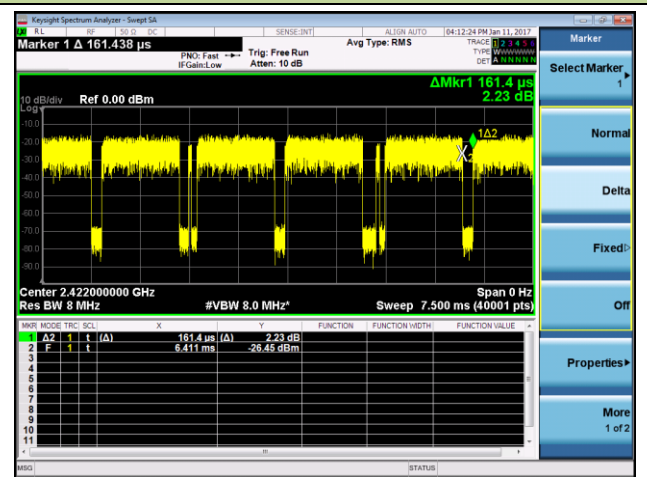
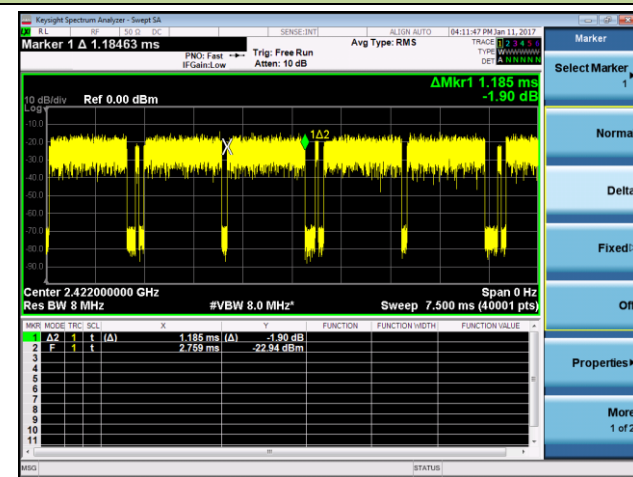

Interference Signal Calibration

Blocking Signal Calibration

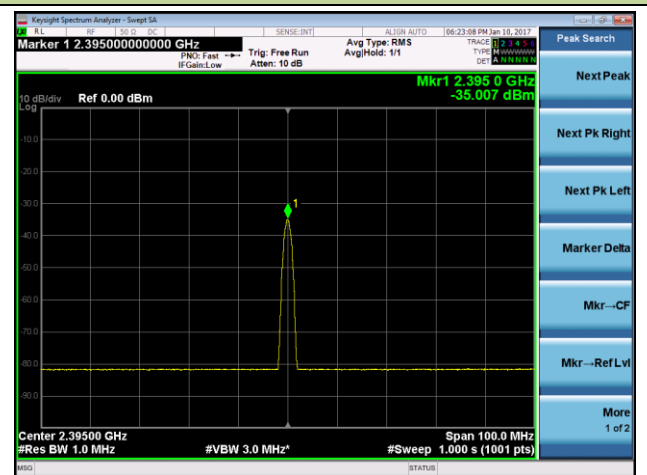

Transmission stopped after interference added and the short control signaling less than 5ms. The UUT did not resume any normal transmissions when adding the blocking signal

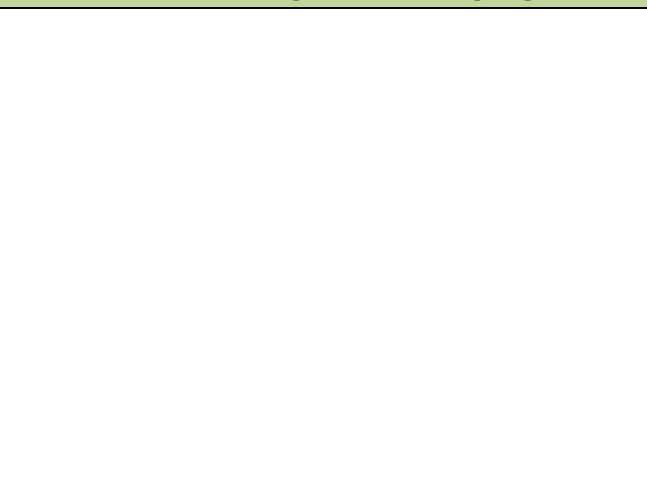
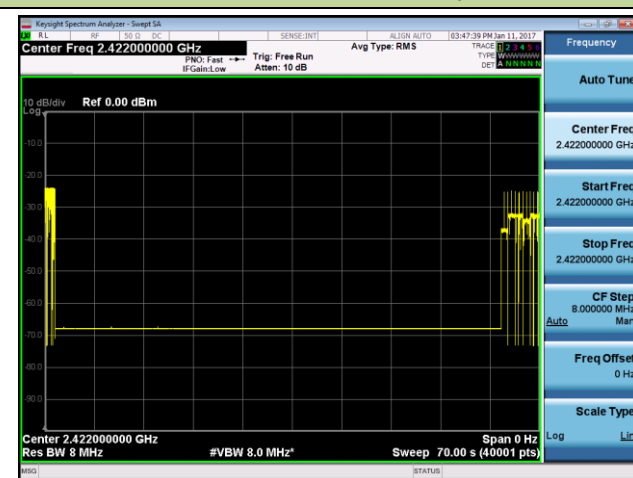

Note: Detection Level = -70 dBm/MHz + (20 dBm - the max conducted power (dBm))/MHz ≥ -70 dBm/MHz We used the worst-case detection level (-70dBm/MHz) to perform adaptivity testing.

Test Result: Pass



802.11n-HT40 - 2462MHz

Maximum Channel Occupancy Time=1.185ms

Minimum Idle Period = 83.0us

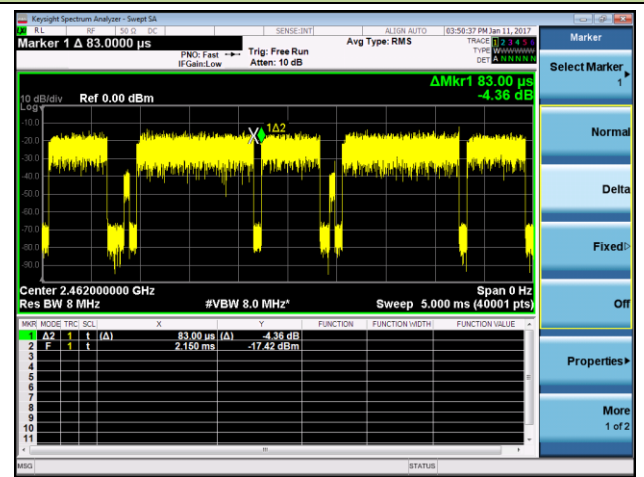
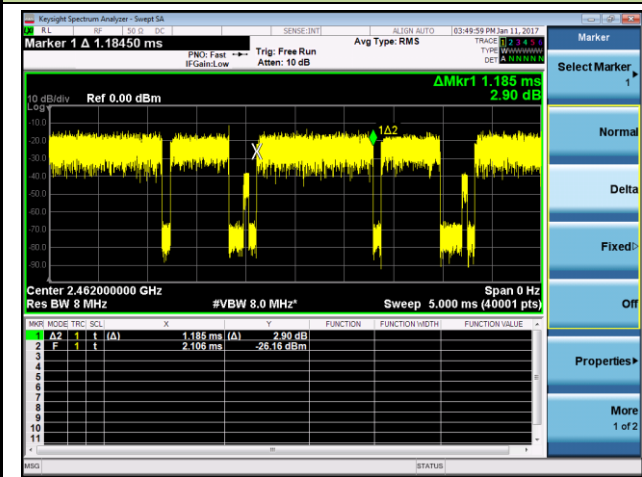

Interference Signal Calibration

Blocking Signal Calibration

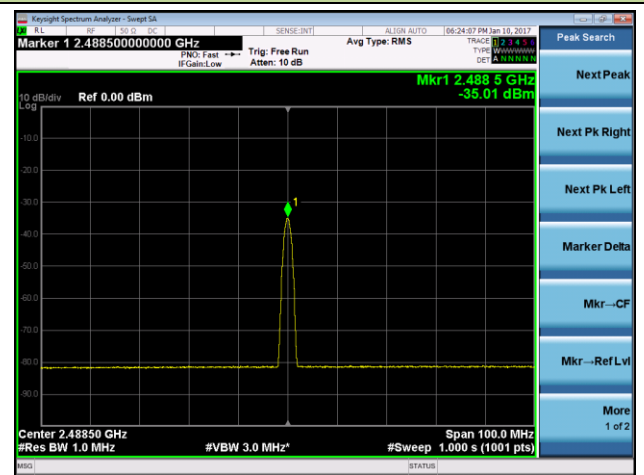

Transmission stopped after interference added and the short control signaling less than 5ms.  
The UUT did not resume any normal transmissions when adding the blocking signal

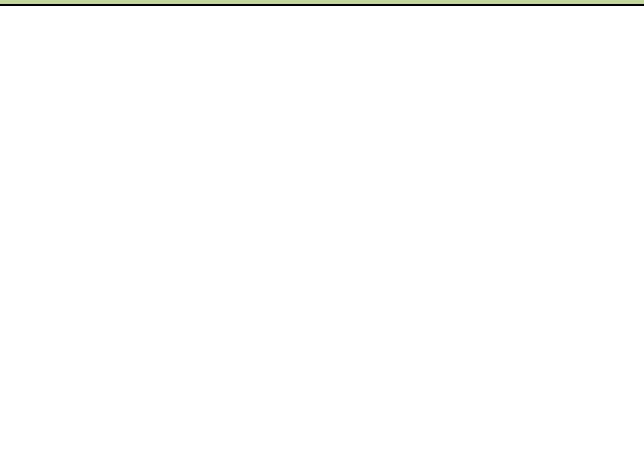
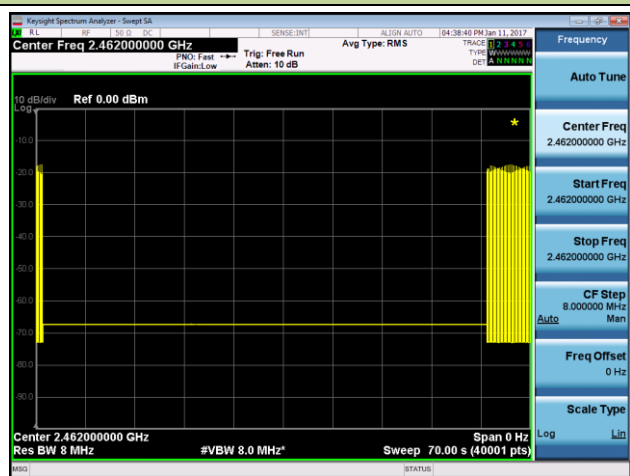

Note: Detection Level =  $-70 \text{ dBm/MHz} + (20 \text{ dBm} - \text{the max conducted power (dBm)})/\text{MHz} \geq -70 \text{ dBm/MHz}$  We used the worst-case detection level (-70dBm/MHz) to perform adaptivity testing.

Test Result: Pass

## 9. Occupied Channel Bandwidth

### 9.1. Limit

The Occupied Channel Bandwidth for each hopping frequency shall fall completely within the band given in 2.4GHz to 2.4835GHz.

### 9.2. Test Setup

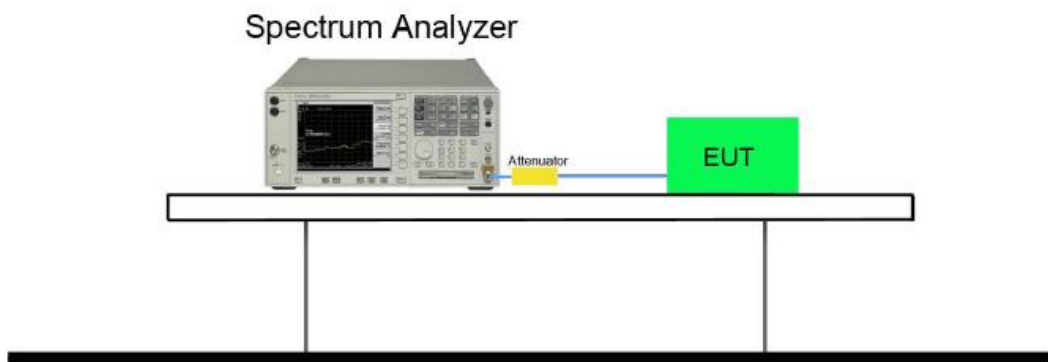

### 9.3. Test Procedure

Refer to ETSI EN 300 328 V1.9.1 (2015-02) Clause 5.3.8.2.1.



#### 9.4. Test Result

Product	802.11ac Dual Band Module	Temperature	24°C
Test Engineer	Roy Cheng	Relative Humidity	54%
Test Site	TR3	Test Date	2016/01/09

The spectrum analyzer setting: RBW  $\approx$  1 % of the span without going below 1 %, VBW  $\geq$  3RBW, Detector Mode = RMS.

Test Mode	Channel No.	Frequency (MHz)	99% Bandwidth (MHz)	Frequency Range (MHz)	Result
<b>Ant 0</b>					
11b	01	2412	11.69	2406.16	Pass
11b	13	2472	11.50	2477.75	Pass
11g	01	2412	16.57	2403.72	Pass
11g	13	2472	16.58	2480.29	Pass
11n-HT20	01	2412	17.76	2403.12	Pass
11n-HT20	13	2472	17.77	2480.89	Pass
11n-HT40	03	2422	36.18	2403.91	Pass
11n-HT40	11	2462	36.19	2480.10	Pass
<b>Ant 1</b>					
11b	01	2412	11.74	2406.13	Pass
11b	13	2472	11.60	2477.80	Pass
11g	01	2412	16.57	2403.72	Pass
11g	13	2472	16.57	2480.29	Pass
11n-HT20	01	2412	17.76	2403.12	Pass
11n-HT20	13	2472	17.77	2480.89	Pass
11n-HT40	03	2422	36.18	2403.91	Pass
11n-HT40	11	2462	36.19	2480.10	Pass
<b>Ant 1 / Ant 0 + 1</b>					
11n-HT20	01	2412	17.75	2403.13	Pass
11n-HT20	13	2472	17.77	2480.89	Pass
11n-HT40	03	2422	36.17	2403.92	Pass
11n-HT40	11	2462	36.19	2480.10	Pass

### 802.11b Occupied Channel Bandwidth - Ant 0

#### Channel 01 (2412MHz)

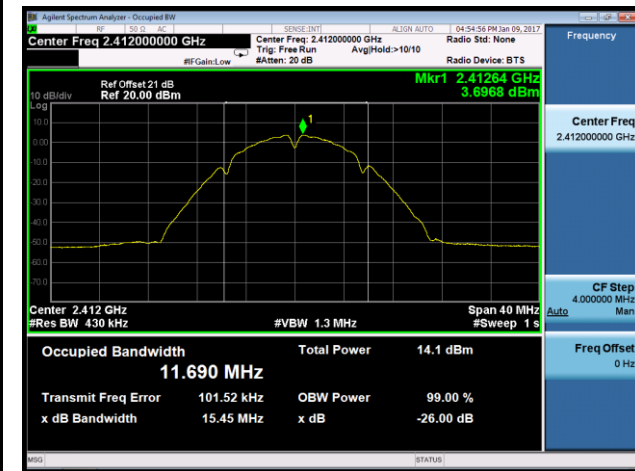

#### Channel 13 (2472MHz)

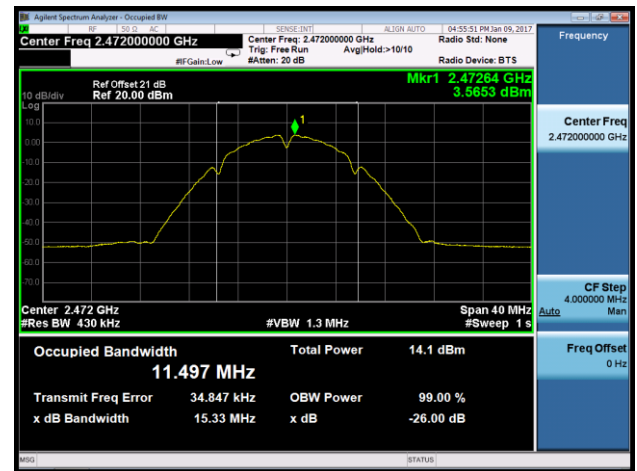

### 802.11g Occupied Channel Bandwidth - Ant 0

#### Channel 01 (2412MHz)

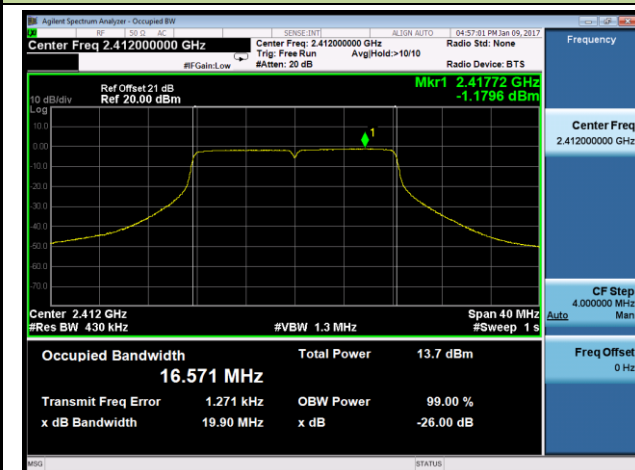

#### Channel 13 (2472MHz)

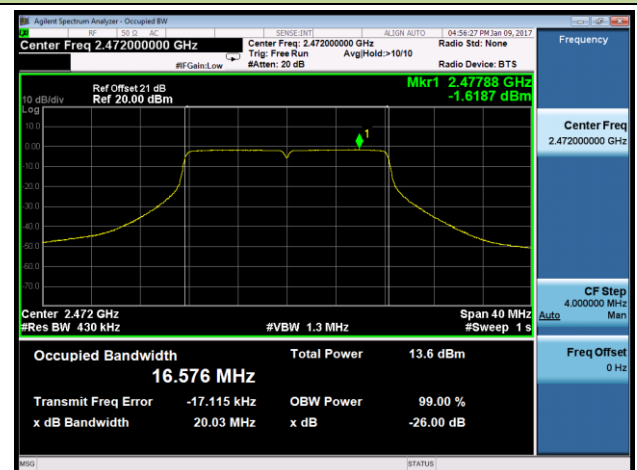

### 802.11n-HT20 Occupied Channel Bandwidth - Ant 0

#### Channel 01 (2412MHz)

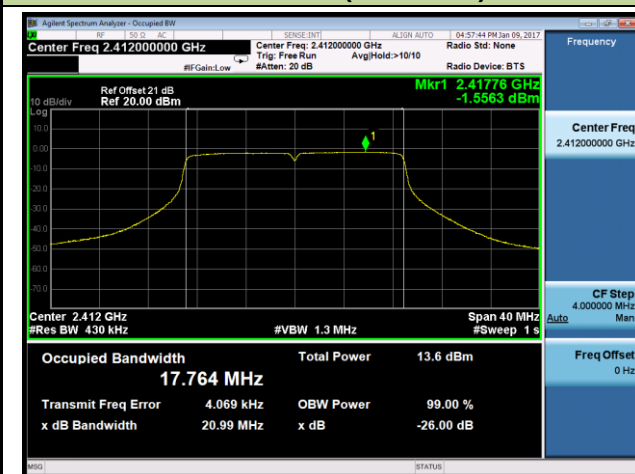

#### Channel 13 (2472MHz)

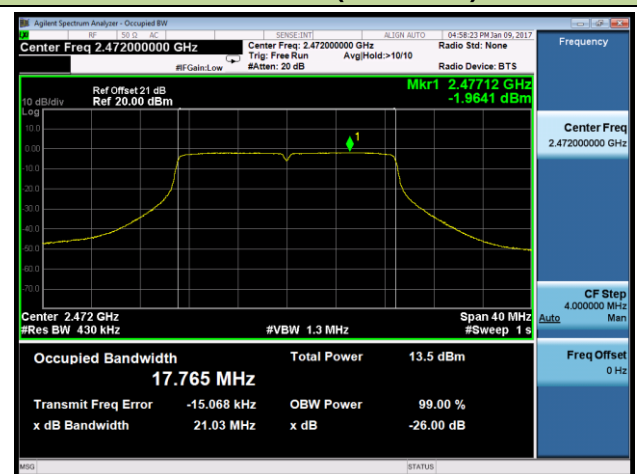

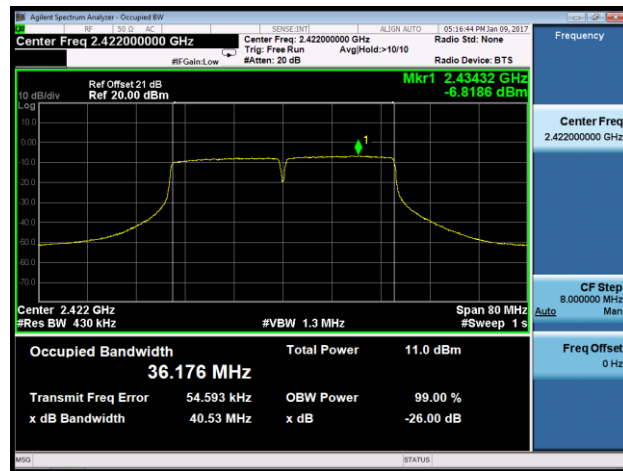
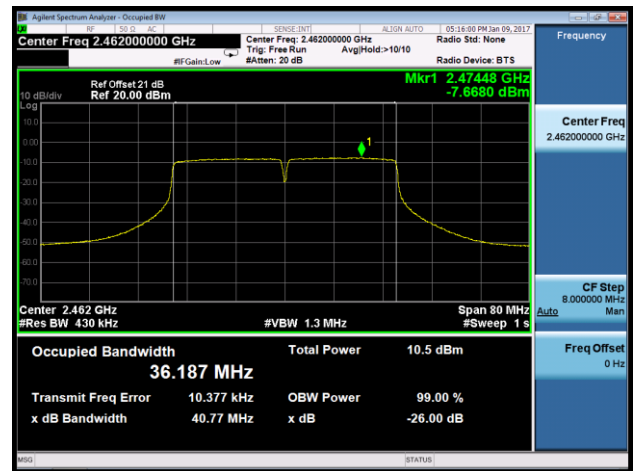
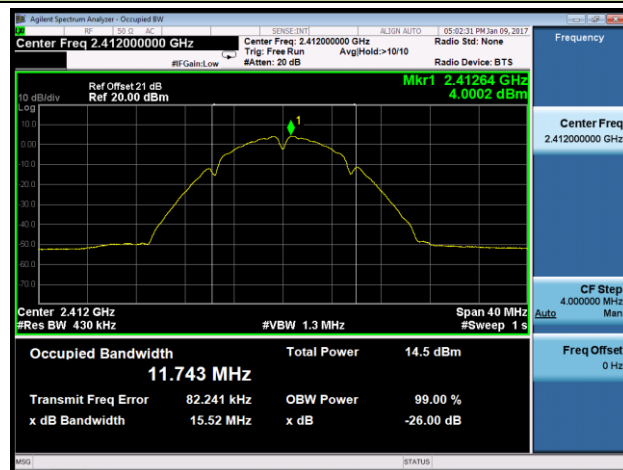
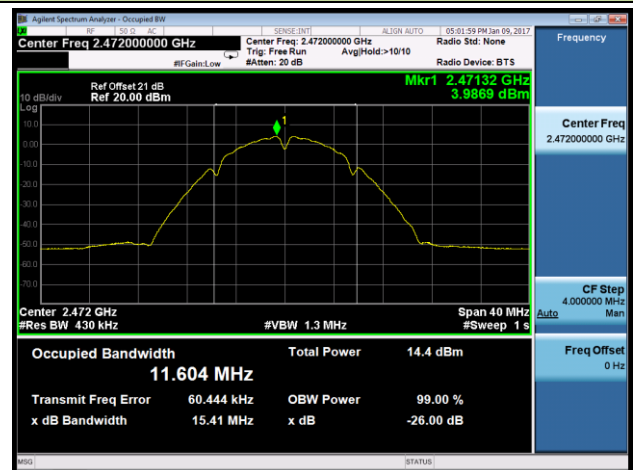
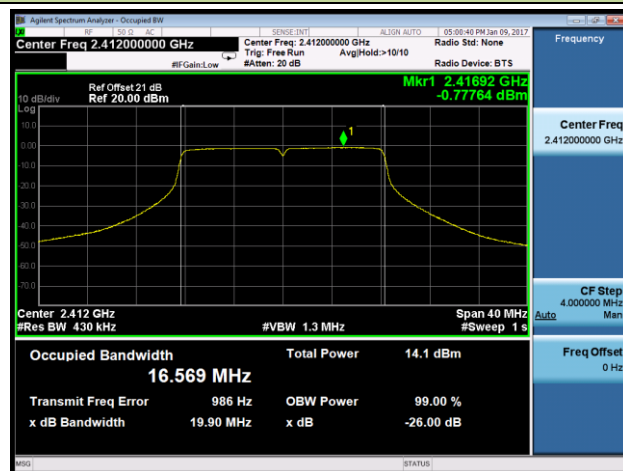
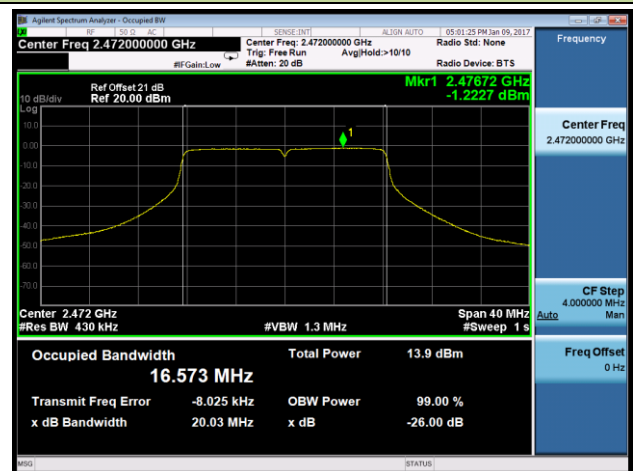
**802.11n-HT40 Occupied Channel Bandwidth - Ant 0**
**Channel 03 (2422MHz)**

**Channel 11 (2462MHz)**

**802.11b Occupied Channel Bandwidth - Ant 1**
**Channel 01 (2412MHz)**

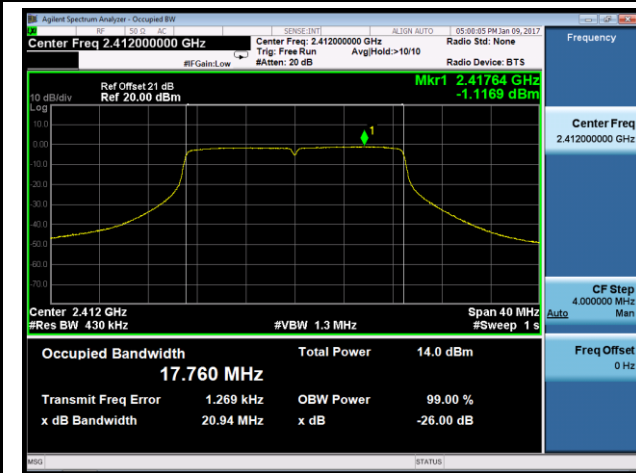
**Channel 13 (2472MHz)**

**802.11g Occupied Channel Bandwidth - Ant 1**
**Channel 01 (2412MHz)**

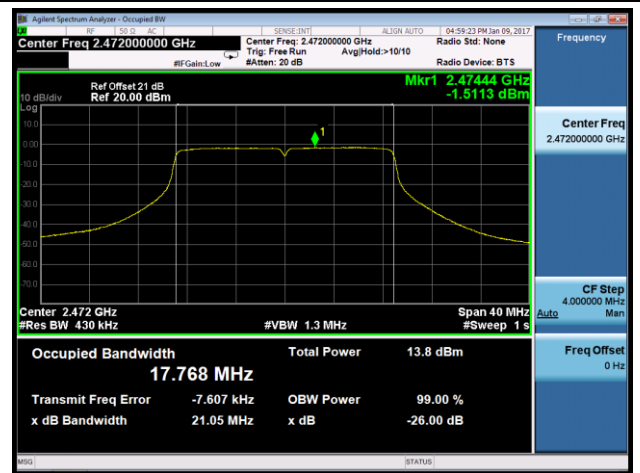
**Channel 13 (2472MHz)**

**802.11n-HT20 Occupied Channel Bandwidth - Ant 1**

**Channel 01 (2412MHz)**



**Channel 13 (2472MHz)**



**802.11n-HT40 Occupied Channel Bandwidth - Ant 1**

**Channel 03 (2422MHz)**

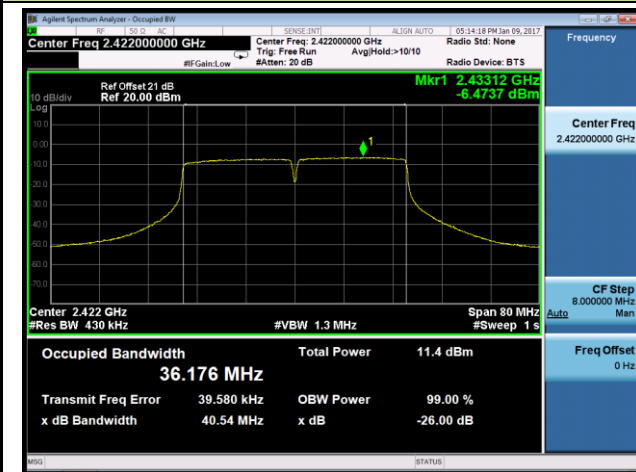

**Channel 11 (2462MHz)**

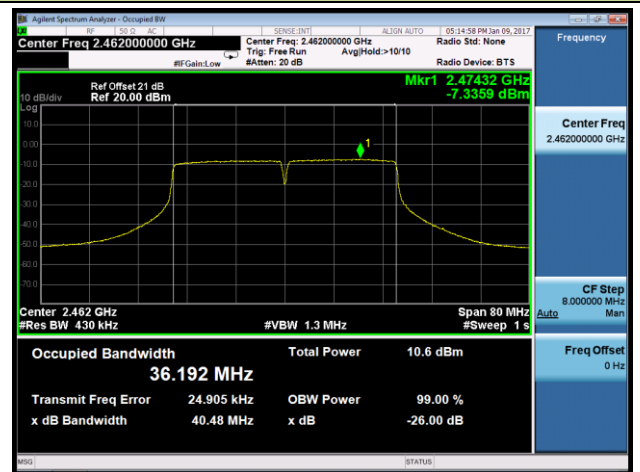

**802.11n-HT20 Occupied Channel Bandwidth - Ant 1 / Ant 0 + 1**

**Channel 01 (2412MHz)**

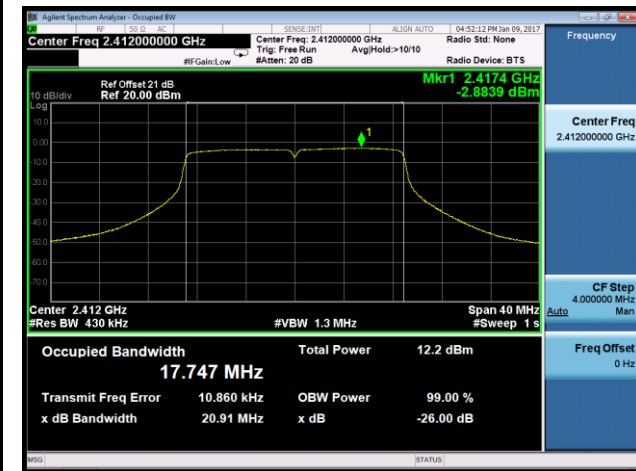

**Channel 13 (2472MHz)**

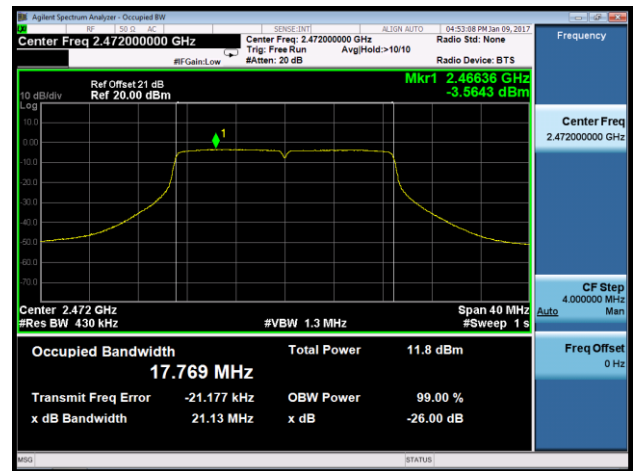

**802.11n-HT40 Occupied Channel Bandwidth - Ant 1 / Ant 0 + 1**

**Channel 03 (2422MHz)**

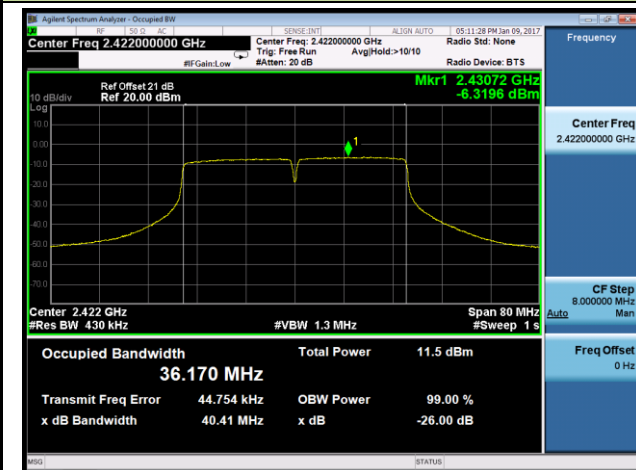

**Channel 11 (2462MHz)**

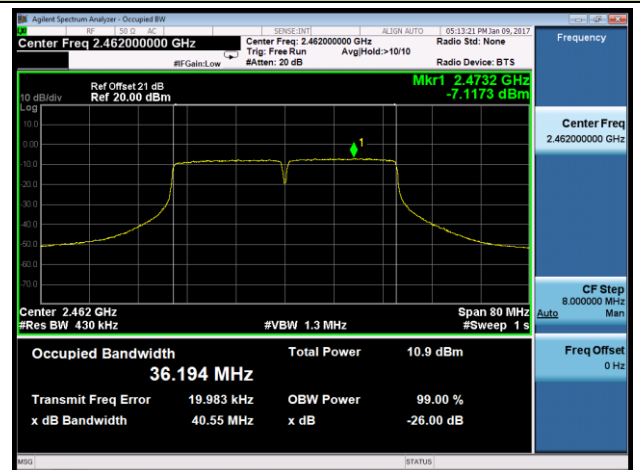

## 10. Transmitter unwanted emissions in the out-of-band domain

### 10.1. Limit

The transmitter unwanted emissions in the out-of-band domain but outside the allocated band, shall not exceed the values provided by the mask in figure 3.

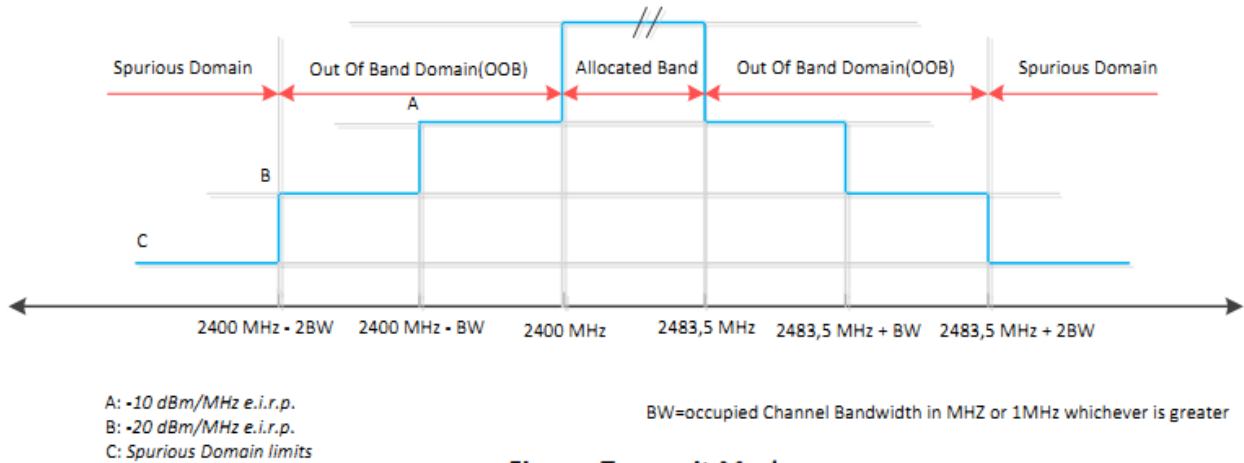
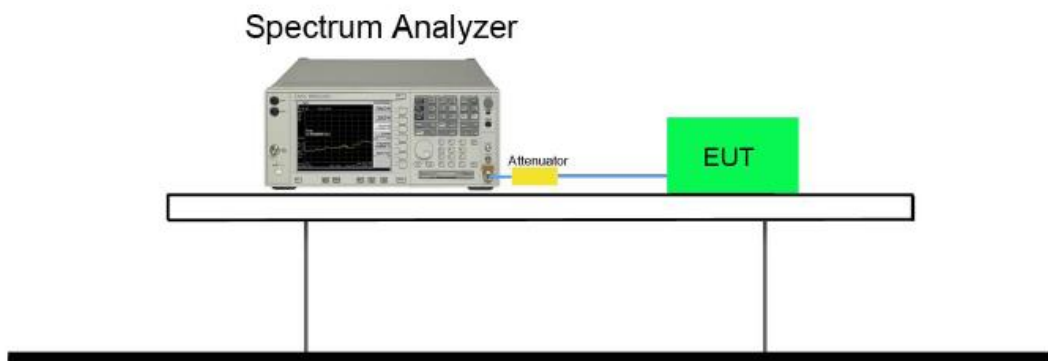

Figure :Transmit Mask

### 10.2. Test Setup

For Conducted Measurement



### 10.3. Test Procedure

Refer to ETSI EN 300 328 V1.9.1 (2015-02) Clause 5.3.9.2.1.

### 10.4. Test Result

Product	802.11ac Dual Band Module	Temperature	22°C
Test Engineer	Roy Cheng	Relative Humidity	52%
Test Site	TR3	Test Date	2017/01/07

Test Mode	Ch. No.	Freq. Range (MHz)	Worst Level (dBm/MHz)	Total Worst Level (dBm/MHz)	Limit (dBm/MHz)	Result
Ant 0						
11b	01	2400-2BW ~ 2400-BW	-34.52	-29.52	-20	Pass
		2483.5+BW ~ 2483.5+2BW	-28.64	-23.64	-10	Pass
	13	2400-2BW ~ 2400-BW	-29.64	-24.64	-10	Pass
		2483.5+BW ~ 2483.5+2BW	-35.91	-30.91	-20	Pass
11g	01	2400-2BW ~ 2400-BW	-31.62	-26.62	-20	Pass
		2483.5+BW ~ 2483.5+2BW	-23.61	-18.61	-10	Pass
	13	2400-2BW ~ 2400-BW	-24.66	-19.66	-10	Pass
		2483.5+BW ~ 2483.5+2BW	-31.06	-26.06	-20	Pass
11n-HT20	01	2400-2BW ~ 2400-BW	-30.11	-25.11	-20	Pass
		2483.5+BW ~ 2483.5+2BW	-21.66	-16.66	-10	Pass
	13	2400-2BW ~ 2400-BW	-21.74	-16.74	-10	Pass
		2483.5+BW ~ 2483.5+2BW	-29.69	-24.69	-20	Pass
11n-HT40	03	2400-2BW ~ 2400-BW	-31.61	-26.61	-20	Pass
		2483.5+BW ~ 2483.5+2BW	-20.61	-15.61	-10	Pass
	11	2400-2BW ~ 2400-BW	-21.46	-16.46	-10	Pass
		2483.5+BW ~ 2483.5+2BW	-30.02	-25.02	-20	Pass

Note: Total Worst Level (dBm/MHz) = Worst Level (dBm/MHz) + Antenna Gain (dBi)

Test Mode	Ch. No.	Freq. Range (MHz)	Worst Level (dBm/MHz)	Total Worst Level (dBm/MHz)	Limit (dBm/MHz)	Result
Ant 1						
11b	01	2400-2BW ~ 2400-BW	-35.61	-30.61	-20	Pass
		2483.5+BW ~ 2483.5+2BW	-27.64	-22.64	-10	Pass
	13	2400-2BW ~ 2400-BW	-28.44	-23.44	-10	Pass
		2483.5+BW ~ 2483.5+2BW	-34.69	-29.69	-20	Pass
11g	01	2400-2BW ~ 2400-BW	-31.25	-26.25	-20	Pass
		2483.5+BW ~ 2483.5+2BW	-23.41	-18.41	-10	Pass
	13	2400-2BW ~ 2400-BW	-22.58	-17.58	-10	Pass
		2483.5+BW ~ 2483.5+2BW	-31.75	-26.75	-20	Pass
11n-HT20	01	2400-2BW ~ 2400-BW	-30.65	-25.65	-20	Pass
		2483.5+BW ~ 2483.5+2BW	-21.84	-16.84	-10	Pass
	13	2400-2BW ~ 2400-BW	-21.86	-16.86	-10	Pass
		2483.5+BW ~ 2483.5+2BW	-30.46	-25.46	-20	Pass
11n-HT40	03	2400-2BW ~ 2400-BW	-32.96	-27.96	-20	Pass
		2483.5+BW ~ 2483.5+2BW	-22.69	-17.69	-10	Pass
	11	2400-2BW ~ 2400-BW	-22.84	-17.84	-10	Pass
		2483.5+BW ~ 2483.5+2BW	-31.69	-26.69	-20	Pass

Note: Total Worst Level (dBm/MHz) = Worst Level (dBm/MHz) + Antenna Gain (dBi)



Test Mode	Ch. No.	Freq. Range (MHz)	Ant 0 Worst Level (dBm/MHz)	Ant 1 Worst Level (dBm/MHz)	Total Worst Level (dBm/MHz)	Limit (dBm/MHz)	Result
Ant 0 + 1							
11n-HT20	01	2400-2BW ~ 2400-BW	-33.62	-34.15	-25.87	-20	Pass
		2483.5+BW ~ 2483.5+2BW	-22.68	-22.52	-14.59	-10	Pass
	13	2400-2BW ~ 2400-BW	-22.18	-22.91	-14.52	-10	Pass
		2483.5+BW ~ 2483.5+2BW	-30.63	-31.52	-23.04	-20	Pass
11n-HT40	03	2400-2BW ~ 2400-BW	-33.65	-34.81	-26.18	-20	Pass
		2483.5+BW ~ 2483.5+2BW	-21.41	-22.87	-14.07	-10	Pass
	11	2400-2BW ~ 2400-BW	-23.45	-22.28	-14.82	-10	Pass
		2483.5+BW ~ 2483.5+2BW	-31.44	-31.69	-23.55	-20	Pass

Note: Total Worst Level (dBm/MHz) =  $10 \cdot \log\{10^{(\text{Ant 0 Worst Level} + \text{Ant 0 Gain}) / 10} + 10^{(\text{Ant 1 Worst Level} + \text{Ant 1 Gain}) / 10}\}$  (dBm/MHz).

## 11. Transmitter Unwanted Emissions in the Spurious Domain

### 11.1. Limit

Transmitter Limits for Spurious Emissions		
Frequency Range	Maximum power	Bandwidth
30 MHz to 47 MHz	-36dBm	100 kHz
47 MHz to 74 MHz	-54dBm	100 kHz
74 MHz to 87,5 MHz	-36dBm	100 kHz
87,5 MHz to 118 MHz	-54dBm	100 kHz
118 MHz to 174 MHz	-36dBm	100 kHz
174 MHz to 230 MHz	-54dBm	100 kHz
230 MHz to 470 MHz	-36dBm	100 kHz
470 MHz to 862 MHz	-54dBm	100 kHz
862 MHz to 1 GHz	-36dBm	100 kHz
1 GHz to 12,75 GHz	-30dBm	1 MHz

### 11.2. Test Setup

30MHz ~ 1GHz Test Setup:

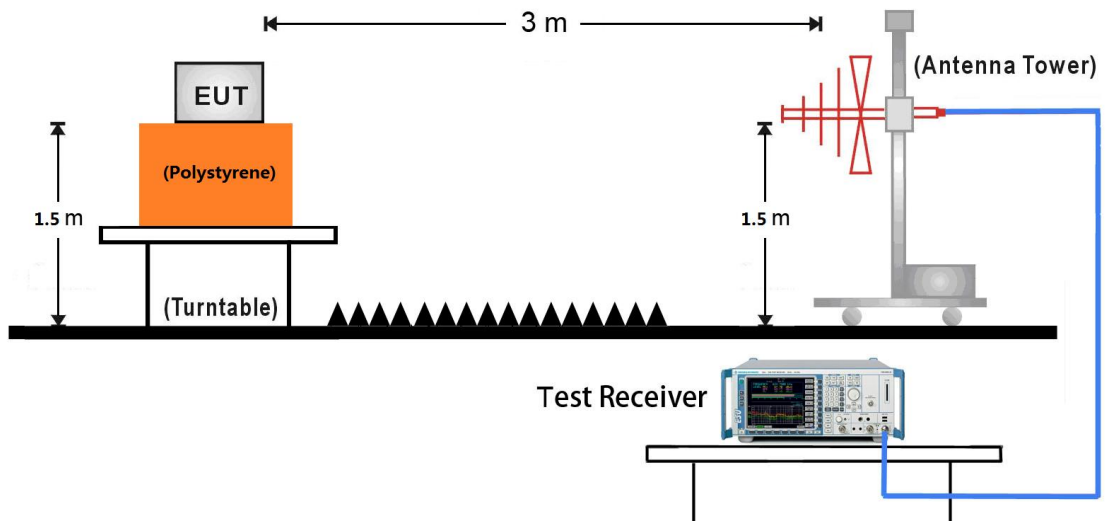

1GHz ~ 12.75GHz Test Setup:

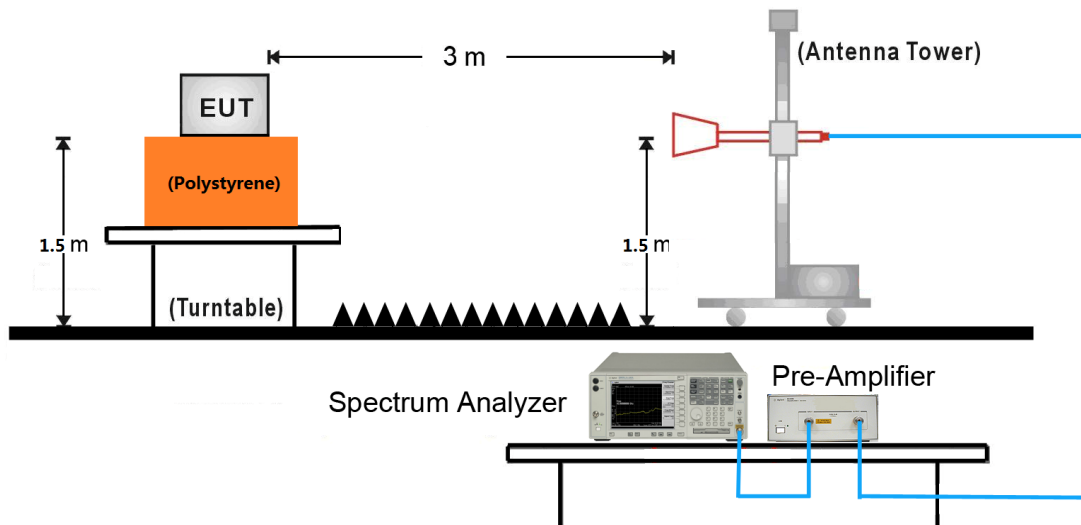

### 11.3. Test Procedure

Refer to ETSI EN 300 328 V1.9.1 (2015-02) Clause 5.3.10.2.2.

### 11.4. Test Result

Test with ANT 2#

Test Engineer	Vince Yu	Temperature	23°C
Test Date	2016/12/31	Relative Humidity	54%
Test Mode	802.11b - Ant 1	Test Site	AC1

Channel	Frequency (MHz)	Reading Level (dBm)	Substitution Factor (dB)	Measure Level (dBm)	Limit (dBm)	Margin (dB)	Detector	Polarization
01	62.0	-88.4	22.9	-65.5	-54.0	-11.5	Peak	Horizontal
	196.8	-86.6	23.2	-63.4	-54.0	-9.4	Peak	Horizontal
	61.5	-87.4	23.0	-64.4	-54.0	-10.4	Peak	Vertical
	205.1	-85.4	21.7	-63.7	-54.0	-9.7	Peak	Vertical
	4936.3	-71.0	16.1	-54.9	-30.0	-24.9	Peak	Horizontal
	9448.3	-72.6	27.2	-45.4	-30.0	-15.4	Peak	Horizontal
	4948.0	-71.5	16.3	-55.2	-30.0	-25.2	Peak	Vertical
	10905.3	-71.9	29.6	-42.3	-30.0	-12.3	Peak	Vertical
13	62.5	-89.0	22.9	-66.1	-54.0	-12.1	Peak	Horizontal
	190.1	-88.4	23.8	-64.6	-54.0	-10.6	Peak	Horizontal
	62.0	-82.4	23.3	-59.1	-54.0	-5.1	RMS	Vertical
	190.1	-86.4	22.0	-64.4	-54.0	-10.4	Peak	Vertical
	4936.3	-62.4	16.1	-46.3	-30.0	-16.3	Peak	Horizontal
	7421.4	-67.9	22.4	-45.5	-30.0	-15.5	Peak	Horizontal
	4942.1	-62.9	16.4	-46.5	-30.0	-16.5	Peak	Vertical
	7409.6	-64.8	22.4	-42.4	-30.0	-12.4	Peak	Vertical

Note 1: Measure Level (dBm) = Reading Level (dBm) + Substitution Factor (dB)

Note 2: Substitution Factor (dB) = Cable Loss (dB) + Space Attenuation (dB) + Antenna Factor (dB/m) - Pre\_Amplifier Gain (dB)



Test Engineer	Vince Yu	Temperature	23°C
Test Date	2016/12/31	Relative Humidity	54%
Test Mode	802.11g - Ant 1	Test Site	AC1

Channel	Frequency (MHz)	Reading Level (dBm)	Substitution Factor (dB)	Measure Level (dBm)	Limit (dBm)	Margin (dB)	Detector	Polarization
01	62.0	-86.9	22.9	-64.0	-54.0	-10.0	Peak	Horizontal
	190.1	-86.4	23.8	-62.6	-54.0	-8.6	Peak	Horizontal
	62.0	-87.4	23.3	-64.1	-54.0	-10.1	Peak	Vertical
	200.2	-84.1	22.5	-61.6	-54.0	-7.6	Peak	Vertical
	4942.1	-70.2	16.2	-54.0	-30.0	-24.0	Peak	Horizontal
	10905.3	-72.6	29.9	-42.7	-30.0	-12.7	Peak	Horizontal
	4942.1	-68.9	16.4	-52.5	-30.0	-22.5	Peak	Vertical
	10729.0	-71.3	29.2	-42.1	-30.0	-12.1	Peak	Vertical
13	62.5	-86.3	22.9	-63.4	-54.0	-9.4	Peak	Horizontal
	190.1	-88.4	23.8	-64.6	-54.0	-10.6	Peak	Horizontal
	66.4	-89.4	24.7	-64.7	-54.0	-10.7	Peak	Vertical
	750.2	-91.5	35.3	-54.8	-54.0	-2.2	RMS	Vertical
	4942.1	-73.6	16.2	-57.4	-30.0	-27.4	Peak	Horizontal
	9648.0	-76.4	27.6	-48.8	-30.0	-18.8	Peak	Horizontal
	4942.1	-71.4	16.4	-55.0	-30.0	-25.0	Peak	Vertical
	7339.1	-73.9	22.3	-51.6	-30.0	-21.6	Peak	Vertical

Note 1: Measure Level (dBm) = Reading Level (dBm) + Substitution Factor (dB)  
 Note 2: Substitution Factor (dB) = Cable Loss (dB) + Space Attenuation (dB) + Antenna Factor (dB/m) - Pre\_Amplifier Gain (dB)

Test Engineer	Vince Yu	Temperature	23°C
Test Date	2016/12/31	Relative Humidity	54%
Test Mode	802.11n-HT20 - Ant 0 + 1	Test Site	AC1

Channel	Frequency (MHz)	Reading Level (dBm)	Substitution Factor (dB)	Measure Level (dBm)	Limit (dBm)	Margin (dB)	Detector	Polarization
01	61.5	-85.9	22.7	-63.2	-54.0	-9.2	Peak	Horizontal
	190.1	-86.6	23.8	-62.8	-54.0	-8.8	Peak	Horizontal
	66.4	-87.4	24.7	-62.7	-54.0	-8.7	Peak	Vertical
	199.8	-87.6	22.5	-65.1	-54.0	-11.1	Peak	Vertical
	7016.0	-72.6	21.1	-51.5	-30.0	-21.5	Peak	Horizontal
	9695.0	-73.7	27.7	-46.0	-30.0	-16.0	Peak	Horizontal
	4830.5	-59.8	15.8	-44.0	-30.0	-14.0	Peak	Vertical
	7233.4	-70.4	22.0	-48.4	-30.0	-18.4	Peak	Vertical
13	62.0	-85.3	22.9	-62.4	-54.0	-8.4	Peak	Horizontal
	190.1	-86.8	23.8	-63.0	-54.0	-9.0	Peak	Horizontal
	62.5	-87.1	23.4	-63.7	-54.0	-9.7	Peak	Vertical
	200.2	-87.9	22.5	-65.4	-54.0	-11.4	Peak	Vertical
	4948.0	-62.1	16.2	-45.9	-30.0	-15.9	Peak	Horizontal
	7415.5	-67.8	22.3	-45.5	-30.0	-15.5	Peak	Horizontal
	4942.1	-62.0	16.4	-45.6	-30.0	-15.6	Peak	Vertical
	7421.4	-65.9	22.7	-43.2	-30.0	-13.2	Peak	Vertical

Note 1: Measure Level (dBm) = Reading Level (dBm) + Substitution Factor (dB)

Note 2: Substitution Factor (dB) = Cable Loss (dB) + Space Attenuation (dB) + Antenna Factor (dB/m) - Pre\_Amplifier Gain (dB)

Test Engineer	Vince Yu	Temperature	23°C
Test Date	2016/12/31	Relative Humidity	54%
Test Mode	802.11n-HT40 - Ant 0 + 1	Test Site	AC1

Channel	Frequency (MHz)	Reading Level (dBm)	Substitution Factor (dB)	Measure Level (dBm)	Limit (dBm)	Margin (dB)	Detector	Polarization
03	62.0	-86.0	22.9	-63.1	-54.0	-9.1	Peak	Horizontal
	190.1	-86.1	23.8	-62.3	-54.0	-8.3	Peak	Horizontal
	65.9	-87.2	24.6	-62.6	-54.0	-8.6	Peak	Vertical
	750.2	-97.8	35.3	-62.5	-54.0	-8.5	Peak	Vertical
	7386.1	-73.3	22.3	-51.0	-30.0	-21.0	Peak	Horizontal
	9648.0	-73.7	27.6	-46.1	-30.0	-16.1	Peak	Horizontal
	6739.9	-71.9	19.7	-52.2	-30.0	-22.2	Peak	Vertical
	9747.9	-74.2	27.9	-46.3	-30.0	-16.3	Peak	Vertical
11	62.0	-86.6	22.9	-63.7	-54.0	-9.7	Peak	Horizontal
	190.1	-86.9	23.8	-63.1	-54.0	-9.1	Peak	Horizontal
	67.3	-88.0	24.6	-63.4	-54.0	-9.4	Peak	Vertical
	200.2	-86.6	22.5	-64.1	-54.0	-10.1	Peak	Vertical
	7168.8	-73.2	22.4	-50.8	-30.0	-20.8	Peak	Horizontal
	10112.1	-73.4	27.9	-45.5	-30.0	-15.5	Peak	Horizontal
	7274.5	-73.6	22.5	-51.1	-30.0	-21.1	Peak	Vertical
	9648.0	-72.9	27.8	-45.1	-30.0	-15.1	Peak	Vertical

Note 1: Measure Level (dBm) = Reading Level (dBm) + Substitution Factor (dB)

Note 2: Substitution Factor (dB) = Cable Loss (dB) + Space Attenuation (dB) + Antenna Factor (dB/m) - Pre\_Amplifier Gain (dB)

## Test with ANT 4#

Test Engineer	Vince Yu	Temperature	23°C
Test Date	2016/12/31	Relative Humidity	54%
Test Mode	802.11b - Ant 1	Test Site	AC1

Channel	Frequency (MHz)	Reading Level (dBm)	Substitution Factor (dB)	Measure Level (dBm)	Limit (dBm)	Margin (dB)	Detector	Polarization
01	117.1	-81.8	17.8	-64.0	-54	-10.0	Peak	Horizontal
	223.3	-92.3	26.7	-65.6	-54	-11.6	Peak	Horizontal
	90.4	-89.5	24.5	-65.0	-54	-11.0	Peak	Vertical
	112.7	-91.2	28.9	-62.3	-54	-8.3	Peak	Vertical
	4788.7	-69.2	15.9	-53.3	-30	-23.3	Peak	Horizontal
	7226.8	-70.1	21.9	-48.2	-30	-18.2	Peak	Horizontal
	4788.7	-69.7	16.1	-53.6	-30	-23.6	Peak	Vertical
	7379.6	-70.1	22.4	-47.7	-30	-17.7	Peak	Vertical
13	117.1	-80.7	17.8	-62.9	-54	-8.9	Peak	Horizontal
	227.7	-91.8	26.8	-65.0	-54	-11.0	Peak	Horizontal
	70.5	-91.2	25.5	-65.7	-54	-11.7	Peak	Vertical
	111.8	-90.1	29.2	-60.9	-54	-6.9	Peak	Vertical
	4806.3	-71.0	16.0	-55.0	-30	-25.0	Peak	Horizontal
	7467.7	-70.0	22.0	-48.0	-30	-18.0	Peak	Horizontal
	4776.9	-69.1	16.0	-53.1	-30	-23.1	Peak	Vertical
	7209.2	-69.4	22.0	-47.4	-30	-17.4	Peak	Vertical

Note 1: Measure Level (dBm) = Reading Level (dBm) + Substitution Factor (dB)

Note 2: Substitution Factor (dB) = Cable Loss (dB) + Space Attenuation (dB) + Antenna Factor (dB/m) - Pre\_Amplifier Gain (dB)



Test Engineer	Vince Yu	Temperature	23°C
Test Date	2016/12/31	Relative Humidity	54%
Test Mode	802.11g - Ant 1	Test Site	AC1

Channel	Frequency (MHz)	Reading Level (dBm)	Substitution Factor (dB)	Measure Level (dBm)	Limit (dBm)	Margin (dB)	Detector	Polarization
01	117.6	-80.9	17.8	-63.1	-36	-27.1	Peak	Horizontal
	141.3	-86.8	21.8	-65.0	-36	-29.0	Peak	Horizontal
	70.0	-91.1	25.4	-65.7	-54	-11.7	Peak	Vertical
	109.8	-90.9	29.2	-61.7	-54	-7.7	Peak	Vertical
	4729.9	-69.5	15.7	-53.8	-30	-23.8	Peak	Horizontal
	7632.2	-70.4	22.2	-48.2	-30	-18.2	Peak	Horizontal
	4794.6	-69.5	16.2	-53.3	-30	-23.3	Peak	Vertical
	7215.1	-69.5	22.0	-47.5	-30	-17.5	Peak	Vertical
13	116.1	-80.6	17.6	-63.0	-54	-9.0	Peak	Horizontal
	221.8	-90.3	26.2	-64.1	-54	-10.1	Peak	Horizontal
	69.6	-91.5	25.3	-66.2	-54	-12.2	Peak	Vertical
	111.3	-89.9	29.2	-60.7	-54	-6.7	Peak	Vertical
	4788.7	-68.9	15.9	-53.0	-30	-23.0	Peak	Horizontal
	7532.3	-69.9	22.0	-47.9	-30	-17.9	Peak	Horizontal
	4753.4	-69.7	16.0	-53.7	-30	-23.7	Peak	Vertical
	7514.7	-69.9	22.4	-47.5	-30	-17.5	Peak	Vertical

Note 1: Measure Level (dBm) = Reading Level (dBm) + Substitution Factor (dB)

Note 2: Substitution Factor (dB) = Cable Loss (dB) + Space Attenuation (dB) + Antenna Factor (dB/m) - Pre\_Amplifier Gain (dB)

Test Engineer	Vince Yu	Temperature	23°C
Test Date	2016/12/31	Relative Humidity	54%
Test Mode	802.11n-HT20 - Ant 0 + 1	Test Site	AC1

Channel	Frequency (MHz)	Reading Level (dBm)	Substitution Factor (dB)	Measure Level (dBm)	Limit (dBm)	Margin (dB)	Detector	Polarization
01	117.1	-81.3	17.8	-63.5	-54	-9.5	Peak	Horizontal
	218.0	-92.3	25.9	-66.4	-54	-12.4	Peak	Horizontal
	69.6	-91.9	25.3	-66.6	-54	-12.6	Peak	Vertical
	112.2	-90.1	29.1	-61.0	-54	-7.0	Peak	Vertical
	4788.7	-69.6	15.9	-53.7	-30	-23.7	Peak	Horizontal
	7109.3	-69.0	21.6	-47.4	-30	-17.4	Peak	Horizontal
	4776.9	-68.4	16.0	-52.4	-30	-22.4	Peak	Vertical
	7267.9	-69.9	22.4	-47.5	-30	-17.5	Peak	Vertical
13	70.5	-91.3	21.5	-69.8	-54	-15.8	Peak	Horizontal
	116.6	-80.5	17.7	-62.8	-54	-8.8	Peak	Horizontal
	70.0	-91.0	25.4	-65.6	-54	-11.6	Peak	Vertical
	111.3	-90.1	29.2	-60.9	-54	-6.9	Peak	Vertical
	4782.8	-69.3	15.8	-53.5	-30	-23.5	Peak	Horizontal
	7209.2	-70.0	21.7	-48.3	-30	-18.3	Peak	Horizontal
	4776.9	-69.1	16.0	-53.1	-30	-23.1	Peak	Vertical
	7367.8	-69.3	22.5	-46.8	-30	-16.8	Peak	Vertical

Note 1: Measure Level (dBm) = Reading Level (dBm) + Substitution Factor (dB)

Note 2: Substitution Factor (dB) = Cable Loss (dB) + Space Attenuation (dB) + Antenna Factor (dB/m) - Pre\_Amplifier Gain (dB)

Test Engineer	Vince Yu	Temperature	23°C
Test Date	2016/12/31	Relative Humidity	54%
Test Mode	802.11n-HT40 - Ant 0 + 1	Test Site	AC1

Channel	Frequency (MHz)	Reading Level (dBm)	Substitution Factor (dB)	Measure Level (dBm)	Limit (dBm)	Margin (dB)	Detector	Polarization
01	96.7	-84.8	17.7	-67.1	-54	-13.1	Peak	Horizontal
	185.0	-88.4	23.1	-65.3	-54	-11.3	Peak	Horizontal
	108.4	-88.4	29.1	-59.3	-54	-5.3	Peak	Vertical
	208.8	-89.7	21.6	-68.1	-54	-14.1	Peak	Vertical
	3860.4	-68.3	12.7	-55.6	-30	-25.6	Peak	Horizontal
	6116.4	-72.4	17.7	-54.7	-30	-24.7	Peak	Horizontal
	5064.8	-70.9	17.4	-53.5	-30	-23.5	Peak	Vertical
	6721.6	-70.9	21.7	-49.2	-30	-19.2	Peak	Vertical
13	101.6	-83.4	18.2	-65.2	-54	-11.2	Peak	Horizontal
	209.2	-94.6	26.1	-68.5	-54	-14.5	Peak	Horizontal
	100.6	-94.2	33.1	-61.1	-54	-7.1	Peak	Vertical
	209.7	-88.5	21.8	-66.7	-54	-12.7	Peak	Vertical
	4665.3	-71.8	15.2	-56.6	-30	-26.6	Peak	Horizontal
	7097.6	-70.7	22.8	-47.9	-30	-17.9	Peak	Horizontal
	4682.9	-71.7	16.3	-55.4	-30	-25.4	Peak	Vertical
	6980.1	-71.9	23.0	-48.9	-30	-18.9	Peak	Vertical

Note 1: Measure Level (dBm) = Reading Level (dBm) + Substitution Factor (dB)

Note 2: Substitution Factor (dB) = Cable Loss (dB) + Space Attenuation (dB) + Antenna Factor (dB/m) - Pre\_Amplifier Gain (dB)

## 12. Receiver Spurious Emissions

### 12.1. Limit

Spurious emissions limits for receivers		
Frequency Range	Maximum power	Measurement bandwidth
30 MHz to 1 GHz	-57dBm	100 kHz
1 GHz to 12.75 GHz	-47dBm	1 MHz

### 12.2. Test Setup

30MHz ~ 1GHz Test Setup:

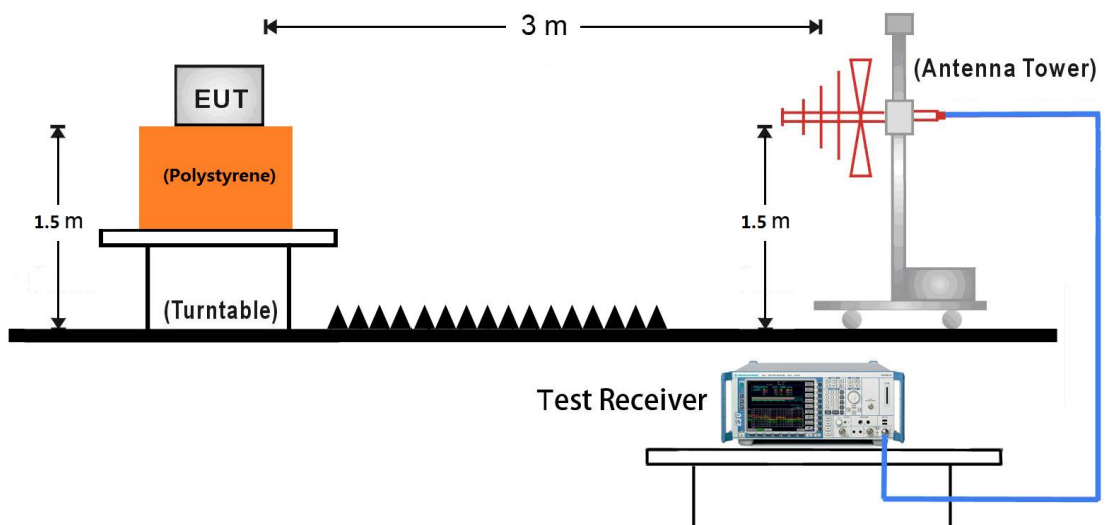

1GHz ~ 12.5GHz Test Setup:

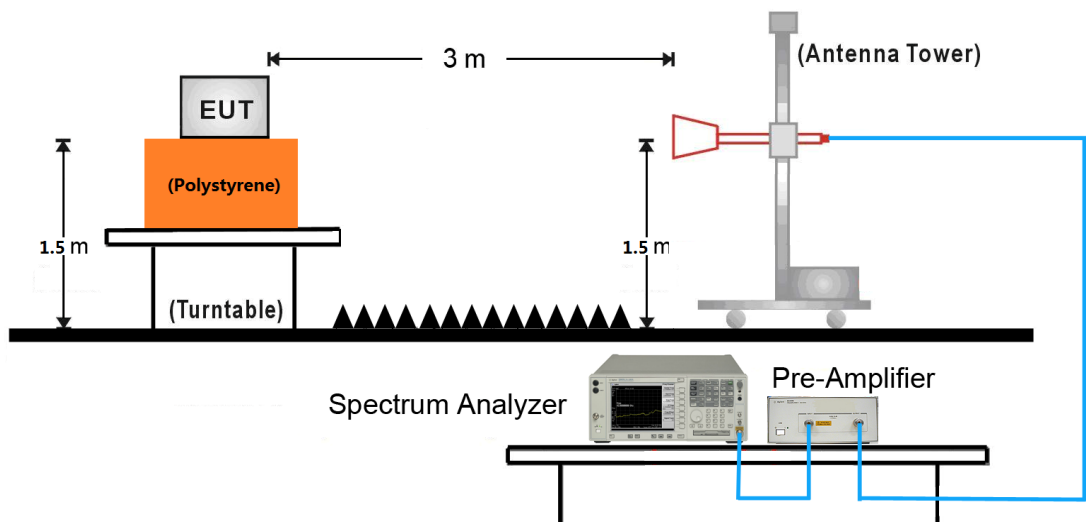

### 12.3. Test Procedure

Refer to ETSI EN 300 328 V1.9.1 (2015-02) Clause 5.3.11.2.2.

## 12.4. Test Result

Test with ANT 2#

Test Engineer	Vince Yu	Temperature	23°C
Test Date	2016/12/31	Relative Humidity	54%
Test Mode	802.11b - Ant 1	Test Site	AC1

Channel	Frequency (MHz)	Reading Level (dBm)	Substitution Factor (dB)	Measure Level (dBm)	Limit (dBm)	Margin (dB)	Detector	Polarization
01	64.4	-91.3	22.7	-68.6	-57.0	-11.6	Peak	Horizontal
	625.1	-96.6	32.6	-64.0	-57.0	-7.0	Peak	Horizontal
	34.9	-86.4	18.8	-67.6	-57.0	-10.6	Peak	Vertical
	115.4	-97.4	28.1	-69.3	-57.0	-12.3	Peak	Vertical
	1123.4	-59.6	2.2	-57.4	-47.0	-10.4	Peak	Horizontal
	2251.4	-69.4	9.5	-59.9	-47.0	-12.9	Peak	Horizontal
	1376.0	-62.4	5.7	-56.7	-47.0	-9.7	Peak	Vertical
	1875.4	-63.5	6.0	-57.5	-47.0	-10.5	Peak	Vertical
13	39.2	-98.6	29.4	-69.2	-57.0	-12.2	Peak	Horizontal
	88.7	-84.6	16.0	-68.6	-57.0	-11.6	Peak	Horizontal
	39.2	-90.3	19.2	-71.1	-57.0	-14.1	Peak	Vertical
	89.7	-91.4	25.1	-66.3	-57.0	-9.3	Peak	Vertical
	1123.4	-56.6	2.2	-54.4	-47.0	-7.4	Peak	Horizontal
	1887.1	-61.8	5.7	-56.1	-47.0	-9.1	Peak	Horizontal
	1352.5	-60.4	4.8	-55.6	-47.0	-8.6	Peak	Vertical
	1875.4	-63.3	6.0	-57.3	-47.0	-10.3	Peak	Vertical

Note 1: Measure Level (dBm) = Reading Level (dBm) + Substitution Factor (dB)

Note 2: Substitution Factor (dB) = Cable Loss (dB) + Space Attenuation (dB) + Antenna Factor (dB/m) - Pre\_Amplifier Gain (dB)

Test Engineer	Vince Yu	Temperature	23°C
Test Date	2016/12/31	Relative Humidity	54%
Test Mode	802.11g - Ant 1	Test Site	AC1

Channel	Frequency (MHz)	Reading Level (dBm)	Substitution Factor (dB)	Measure Level (dBm)	Limit (dBm)	Margin (dB)	Detector	Polarization
01	39.2	-97.6	29.4	-68.2	-57.0	-11.2	Peak	Horizontal
	125.5	-88.6	19.2	-69.4	-57.0	-12.4	Peak	Horizontal
	34.4	-87.9	18.8	-69.1	-57.0	-12.1	Peak	Vertical
	110.5	-96.4	29.2	-67.2	-57.0	-10.2	Peak	Vertical
	1123.4	-59.6	2.2	-57.4	-47.0	-10.4	Peak	Horizontal
	2251.4	-64.8	9.5	-55.3	-47.0	-8.3	Peak	Horizontal
	1376.0	-64.9	5.7	-59.2	-47.0	-12.2	Peak	Vertical
	1875.4	-67.3	6.0	-61.3	-47.0	-14.3	Peak	Vertical
13	39.2	-97.5	29.4	-68.1	-57.0	-11.1	Peak	Horizontal
	127.5	-90.3	19.5	-70.8	-57.0	-13.8	Peak	Horizontal
	59.6	-90.1	22.3	-67.8	-57.0	-10.8	Peak	Vertical
	250.2	-88.6	22.1	-66.5	-57.0	-9.5	Peak	Vertical
	1123.4	-58.6	2.2	-56.4	-47.0	-9.4	Peak	Horizontal
	2251.4	-69.4	9.5	-59.9	-47.0	-12.9	Peak	Horizontal
	1352.5	-60.6	4.8	-55.8	-47.0	-8.8	Peak	Vertical
	2251.4	-67.8	9.0	-58.8	-47.0	-11.8	Peak	Vertical

Note 1: Measure Level (dBm) = Reading Level (dBm) + Substitution Factor (dB)

Note 2: Substitution Factor (dB) = Cable Loss (dB) + Space Attenuation (dB) + Antenna Factor (dB/m) - Pre\_Amplifier Gain (dB)

Test Engineer	Vince Yu	Temperature	23°C
Test Date	2016/12/31	Relative Humidity	54%
Test Mode	802.11n-HT20 - Ant 0 + 1 + 2	Test Site	AC1

Channel	Frequency (MHz)	Reading Level (dBm)	Substitution Factor (dB)	Measure Level (dBm)	Limit (dBm)	Margin (dB)	Detector	Polarization
01	64.0	-91.1	22.6	-68.5	-57.0	-11.5	Peak	Horizontal
	127.5	-84.5	19.5	-65.0	-57.0	-8.0	Peak	Horizontal
	33.9	-84.7	18.6	-66.1	-57.0	-9.1	Peak	Vertical
	64.4	-87.5	23.9	-63.6	-57.0	-6.6	Peak	Vertical
	1123.4	-55.4	2.2	-53.2	-47.0	-6.2	Peak	Horizontal
	2251.4	-66.4	9.5	-56.9	-47.0	-9.9	Peak	Horizontal
	1352.5	-59.2	4.8	-54.4	-47.0	-7.4	Peak	Vertical
	2251.4	-64.9	9.0	-55.9	-47.0	-8.9	Peak	Vertical
13	89.7	-82.3	15.9	-66.4	-57.0	-9.4	Peak	Horizontal
	125.1	-85.0	19.1	-65.9	-57.0	-8.9	Peak	Horizontal
	60.1	-87.9	22.3	-65.6	-57.0	-8.6	Peak	Vertical
	250.2	-87.2	22.1	-65.1	-57.0	-8.1	Peak	Vertical
	1123.4	-56.6	2.2	-54.4	-47.0	-7.4	Peak	Horizontal
	2251.4	-67.1	9.5	-57.6	-47.0	-10.6	Peak	Horizontal
	1376.0	-60.9	5.7	-55.2	-47.0	-8.2	Peak	Vertical
	1875.4	-63.1	6.0	-57.1	-47.0	-10.1	Peak	Vertical

Note 1: Measure Level (dBm) = Reading Level (dBm) + Substitution Factor (dB)

Note 2: Substitution Factor (dB) = Cable Loss (dB) + Space Attenuation (dB) + Antenna Factor (dB/m) - Pre\_Amplifier Gain (dB)

Test Engineer	Vince Yu	Temperature	23°C
Test Date	2016/12/31	Relative Humidity	54%
Test Mode	802.11n-HT40 - Ant 0 + 1 + 2	Test Site	AC1

Channel	Frequency (MHz)	Reading Level (dBm)	Substitution Factor (dB)	Measure Level (dBm)	Limit (dBm)	Margin (dB)	Detector	Polarization
03	97.4	-81.5	14.7	-66.8	-57.0	-9.8	Peak	Horizontal
	125.1	-85.1	19.1	-66.0	-57.0	-9.0	Peak	Horizontal
	33.9	-85.8	18.6	-67.2	-57.0	-10.2	Peak	Vertical
	59.6	-87.6	22.3	-65.3	-57.0	-8.3	Peak	Vertical
	1123.4	-55.4	2.2	-53.2	-47.0	-6.2	Peak	Horizontal
	2251.4	-65.0	9.5	-55.5	-47.0	-8.5	Peak	Horizontal
	1352.5	-59.7	4.8	-54.9	-47.0	-7.9	Peak	Vertical
	1875.4	-62.6	6.0	-56.6	-47.0	-9.6	Peak	Vertical
11	62.5	-91.6	22.9	-68.7	-57.0	-11.7	Peak	Horizontal
	127.5	-85.9	19.5	-66.4	-57.0	-9.4	Peak	Horizontal
	57.2	-88.4	22.0	-66.4	-57.0	-9.4	Peak	Vertical
	250.2	-89.9	22.1	-67.8	-57.0	-10.8	Peak	Vertical
	1123.4	-57.3	2.2	-55.1	-47.0	-8.1	Peak	Horizontal
	2251.4	-68.2	9.5	-58.7	-47.0	-11.7	Peak	Horizontal
	1352.5	-60.1	4.8	-55.3	-47.0	-8.3	Peak	Vertical
	1875.4	-62.8	6.0	-56.8	-47.0	-9.8	Peak	Vertical

Note 1: Measure Level (dBm) = Reading Level (dBm) + Substitution Factor (dB)

Note 2: Substitution Factor (dB) = Cable Loss (dB) + Space Attenuation (dB) + Antenna Factor (dB/m) - Pre\_Amplifier Gain (dB)



## Test with ANT 4#

Test Engineer	Vince Yu	Temperature	23°C
Test Date	2016/12/31	Relative Humidity	54%
Test Mode	802.11b - Ant 1	Test Site	AC1

Channel	Frequency (MHz)	Reading Level (dBm)	Substitution Factor (dB)	Measure Level (dBm)	Limit (dBm)	Margin (dB)	Detector	Polarization
01	140.4	-85.9	21.9	-64.0	-57	-7.0	Peak	Horizontal
	253.9	-91.4	24.8	-66.6	-57	-9.6	Peak	Horizontal
	69.1	-92.2	25.1	-67.1	-57	-10.1	Peak	Vertical
	96.7	-88.2	24.1	-64.1	-57	-7.1	Peak	Vertical
	1357.7	-63.4	5.6	-57.8	-47	-10.8	Peak	Horizontal
	3590.2	-68.4	13.3	-55.1	-47	-8.1	Peak	Horizontal
	1246.1	-62.8	4.9	-57.9	-47	-10.9	Peak	Vertical
	2896.9	-66.9	10.7	-56.2	-47	-9.2	Peak	Vertical
13	140.4	-86.3	21.9	-64.4	-57	-7.4	Peak	Horizontal
	234.5	-93.3	28.3	-65.0	-57	-8.0	Peak	Horizontal
	84.6	-92.1	26.7	-65.4	-57	-8.4	Peak	Vertical
	254.3	-91.1	23.1	-68.0	-57	-11.0	Peak	Vertical
	1357.7	-63.7	5.6	-58.1	-47	-11.1	Peak	Horizontal
	3137.8	-68.9	11.6	-57.3	-47	-10.3	Peak	Horizontal
	2168.4	-66.6	9.2	-57.4	-47	-10.4	Peak	Vertical
	3214.2	-67.8	12.0	-55.8	-47	-8.8	Peak	Vertical

Note 1: Measure Level (dBm) = Reading Level (dBm) + Substitution Factor (dB)

Note 2: Substitution Factor (dB) = Cable Loss (dB) + Space Attenuation (dB) + Antenna Factor (dB/m) - Pre\_Amplifier Gain (dB)

Test Engineer	Vince Yu	Temperature	23°C
Test Date	2016/12/31	Relative Humidity	54%
Test Mode	802.11g - Ant 1	Test Site	AC1

Channel	Frequency (MHz)	Reading Level (dBm)	Substitution Factor (dB)	Measure Level (dBm)	Limit (dBm)	Margin (dB)	Detector	Polarization
01	233.0	-94.4	28.3	-66.1	-57	-9.1	Peak	Horizontal
	289.3	-89.7	22.3	-67.4	-57	-10.4	Peak	Horizontal
	140.9	-91.9	24.3	-67.6	-57	-10.6	Peak	Vertical
	247.6	-90.8	21.7	-69.1	-57	-12.1	Peak	Vertical
	1340.1	-62.9	4.5	-58.4	-47	-11.4	Peak	Horizontal
	3601.9	-68.6	13.3	-55.3	-47	-8.3	Peak	Horizontal
	1157.9	-62.5	4.2	-58.3	-47	-11.3	Peak	Vertical
	3690.1	-67.7	13.4	-54.3	-47	-7.3	Peak	Vertical
13	141.8	-86.2	21.7	-64.5	-57	-7.5	Peak	Horizontal
	256.3	-92.6	25.1	-67.5	-57	-10.5	Peak	Horizontal
	140.4	-92.0	24.3	-67.7	-57	-10.7	Peak	Vertical
	252.9	-89.7	22.7	-67.0	-57	-10.0	Peak	Vertical
	1351.8	-63.1	5.3	-57.8	-47	-10.8	Peak	Horizontal
	3860.4	-67.1	13.8	-53.3	-47	-6.3	Peak	Horizontal
	1263.7	-62.6	4.0	-58.6	-47	-11.6	Peak	Vertical
	3114.3	-67.9	11.6	-56.3	-47	-9.3	Peak	Vertical

Note 1: Measure Level (dBm) = Reading Level (dBm) + Substitution Factor (dB)

Note 2: Substitution Factor (dB) = Cable Loss (dB) + Space Attenuation (dB) + Antenna Factor (dB/m) - Pre\_Amplifier Gain (dB)

Test Engineer	Vince Yu	Temperature	23°C
Test Date	2016/12/31	Relative Humidity	54%
Test Mode	802.11n-HT20 - Ant 0 + 1 + 2	Test Site	AC1

Channel	Frequency (MHz)	Reading Level (dBm)	Substitution Factor (dB)	Measure Level (dBm)	Limit (dBm)	Margin (dB)	Detector	Polarization
01	141.3	-84.6	21.8	-62.8	-57	-5.8	Peak	Horizontal
	234.0	-95.2	28.3	-66.9	-57	-9.9	Peak	Horizontal
	134.5	-91.8	24.4	-67.4	-57	-10.4	Peak	Vertical
	255.8	-90.6	23.5	-67.1	-57	-10.1	Peak	Vertical
	2244.8	-67.7	9.5	-58.2	-47	-11.2	Peak	Horizontal
	3707.7	-67.7	13.3	-54.4	-47	-7.4	Peak	Horizontal
	1240.2	-63.0	4.9	-58.1	-47	-11.1	Peak	Vertical
	2174.3	-67.4	9.1	-58.3	-47	-11.3	Peak	Vertical
13	141.3	-86.5	21.8	-64.7	-57	-7.7	Peak	Horizontal
	259.7	-91.5	25.6	-65.9	-57	-8.9	Peak	Horizontal
	136.5	-92.2	24.4	-67.8	-57	-10.8	Peak	Vertical
	252.4	-90.2	22.6	-67.6	-57	-10.6	Peak	Vertical
	2256.6	-67.5	9.4	-58.1	-47	-11.1	Peak	Horizontal
	3807.6	-67.4	13.8	-53.6	-47	-6.6	Peak	Horizontal
	1674.9	-64.6	5.1	-59.5	-47	-12.5	Peak	Vertical
	2996.8	-68.0	10.9	-57.1	-47	-10.1	Peak	Vertical

Note 1: Measure Level (dBm) = Reading Level (dBm) + Substitution Factor (dB)

Note 2: Substitution Factor (dB) = Cable Loss (dB) + Space Attenuation (dB) + Antenna Factor (dB/m) - Pre\_Amplifier Gain (dB)

Test Engineer	Vince Yu	Temperature	23°C
Test Date	2016/12/31	Relative Humidity	54%
Test Mode	802.11n-HT40 - Ant 0 + 1 + 2	Test Site	AC1

Channel	Frequency (MHz)	Reading Level (dBm)	Substitution Factor (dB)	Measure Level (dBm)	Limit (dBm)	Margin (dB)	Detector	Polarization
03	233.5	-95.7	28.3	-67.4	-57	-10.4	Peak	Horizontal
	300.4	-90.9	23.8	-67.1	-57	-10.1	Peak	Horizontal
	140.4	-92.4	24.3	-68.1	-57	-11.1	Peak	Vertical
	254.8	-90.0	23.2	-66.8	-57	-9.8	Peak	Vertical
	1357.7	-64.3	5.6	-58.7	-47	-11.7	Peak	Horizontal
	4630.1	-68.3	15.5	-52.8	-47	-5.8	Peak	Horizontal
	1246.1	-63.7	4.9	-58.8	-47	-11.8	Peak	Vertical
	3778.2	-68.4	13.7	-54.7	-47	-7.7	Peak	Vertical
11	141.8	-86.0	21.7	-64.3	-57	-7.3	Peak	Horizontal
	255.8	-91.0	25.0	-66.0	-57	-9.0	Peak	Horizontal
	139.9	-91.9	24.3	-67.6	-57	-10.6	Peak	Vertical
	252.9	-91.5	22.7	-68.8	-57	-11.8	Peak	Vertical
	2174.3	-66.4	8.6	-57.8	-47	-10.8	Peak	Horizontal
	3813.4	-67.9	13.7	-54.2	-47	-7.2	Peak	Horizontal
	1240.2	-63.4	4.9	-58.5	-47	-11.5	Peak	Vertical
	3020.3	-67.9	11.5	-56.4	-47	-9.4	Peak	Vertical

Note 1: Measure Level (dBm) = Reading Level (dBm) + Substitution Factor (dB)

Note 2: Substitution Factor (dB) = Cable Loss (dB) + Space Attenuation (dB) + Antenna Factor (dB/m) - Pre\_Amplifier Gain (dB)

### 13. Measurement Uncertainty

Where relevant, the following measurement uncertainty levels have been estimated for tests performed on the apparatus:

Parameter	Uncertainty
Occupied Channel Bandwidth	$\pm 5 \%$
RF output power, conducted	$\pm 1,5 \text{ dB}$
Power Spectral Density, conducted	$\pm 3 \text{ dB}$
Unwanted Emissions, conducted	$\pm 3 \text{ dB}$
All emissions, radiated	$\pm 6 \text{ dB}$
Temperature	$\pm 3 \text{ }^\circ\text{C}$
Supply voltages	$\pm 3 \%$
Time	$\pm 5 \%$

## 14. List of Measuring Instrument

### Equivalent Isotropic Radiated Power - TR3

Instrument	Manufacturer	Type No.	Serial No.	Cali. Interval	Cali. Due Date
USB wideband power sensor	Boonton	55006	8911	1 year	2017/05/08
Programmable Temperature & Humidity Chamber	BAOYT	BYH-1500L	1309W043	1 year	2017/12/08
Temperature/Humidity Meter	Yuhuaze	HTC-2	N/A	1 year	2017/12/20

### Power Spectral Density - TR3

Instrument	Manufacturer	Type No.	Serial No.	Cali. Interval	Cali. Due Date
Spectrum Analyzer	Agilent	N9020A	MY52090106	1 year	2017/05/07
Temperature/Humidity Meter	Yuhuaze	HTC-2	N/A	1 year	2017/12/20

### Duty Cycle, Tx-sequence, Tx-gap - TR3

Instrument	Manufacturer	Type No.	Serial No.	Cali. Interval	Cali. Due Date
Spectrum Analyzer	Agilent	N9020A	MY52090106	1 year	2017/05/07
Temperature/Humidity Meter	Yuhuaze	HTC-2	N/A	1 year	2017/12/20

### Medium Utilisation (MU) Factor - TR3

Instrument	Manufacturer	Type No.	Serial No.	Cali. Interval	Cali. Due Date
Spectrum Analyzer	Agilent	N9020A	MY52090106	1 year	2017/05/07
USB wideband power sensor	Boonton	55006	8911	1 year	2017/05/08
Temperature/Humidity Meter	Yuhuaze	HTC-2	N/A	1 year	2017/12/20

### Adaptivity and Blocking - TR3

Instrument	Manufacturer	Type No.	Serial No.	Cali. Interval	Cali. Due Date
Spectrum Analyzer	Agilent	N9020A	MY52090106	1 year	2017/05/07
Vector Signal Generator	Agilent	E4438C	MY49872484	1 year	2017/12/08
Vector Signal Generator	Agilent	E4438C	MY49071305	1 year	2017/12/08
Directional Coupler	Narda	4216-20	MRTSUE06065	1 year	2017/03/28
Power Splitter	Mini-Circuits	ZFRSC-123-S+	N/A	N/A	N/A
Temperature/Humidity Meter	Yuhuaze	HTC-2	N/A	1 year	2017/12/20

## Occupied Channel Bandwidth - TR3

Instrument	Manufacturer	Type No.	Serial No.	Cali. Interval	Cali. Due Date
Spectrum Analyzer	Agilent	N9020A	MY52090106	1 year	2017/05/07
Temperature/Humidity Meter	Yuhuaze	HTC-2	N/A	1 year	2017/12/20

## Transmitter Unwanted Emissions in the out-of-band Domain - TR3

Instrument	Manufacturer	Type No.	Serial No.	Cali. Interval	Cali. Due Date
Spectrum Analyzer	Agilent	N9020A	MY52090106	1 year	2017/05/07
Programmable Temperature & Humidity Chamber	BAOYT	BYH-1500L	1309W043	1 year	2017/12/08
Temperature/Humidity Meter	Yuhuaze	HTC-2	N/A	1 year	2017/12/20

## Transmitter Spurious Emissions and Receiver Spurious Emissions - AC1

Instrument	Manufacturer	Type No.	Serial No.	Cali. Interval	Cal. Due Date
Spectrum Analyzer	Agilent	N9020A	MY52090106	1 year	2017/05/07
Microwave System Amplifier	Agilent	83017A	MY53270040	1 year	2017/03/28
Bilog Period Antenna	Schwarzbeck	VULB 9168	662	1 year	2017/12/11
Horn Antenna	Schwarzbeck	BBHA9120D	9120D-1167	1 year	2017/11/07
Temperature/Humidity Meter	Yuhuaze	HTC-2	N/A	1 year	2017/12/20
Anechoic Chamber	TDK	Chamber-AC1	N/A	1 year	2017/05/10

Software	Version	Function
e3	V8.3.5	EMI Test Software

\_\_\_\_\_ The End \_\_\_\_\_